

YAESU
The radio

VHF/UHF C4FM/FM
50W AMS DIGITAL REPEATER

DR-2X DR-2XE

Operating Manual







Contents

Introduction	1	8. Set up DP-ID	21
Features of this repeater	1	Digital Personal Identification (DP-ID)	21
About the touch panel	1	9. Basic Set up and Operations	23
Safety Precautions (make sure to read these)	1	Stand Alone Operation	23
Setting up the Repeater	3	10. Advanced Set up and Operations	24
Safety measures for installation	3	IMRS (Internet-linked Multi-site Repeater System) ..	24
Installing the repeater	3	11. Remote Controls	26
About electrical grounding.....	3	Setting the remote control	26
Connecting Antenna Cables.....	4	C4FM DIGITAL CONTROL.....	27
Select downlink antenna	4	DTMF (for analog FM mode).....	27
Connecting the Power Supply	5	Change the remote command.....	28
Connecting External Devices	6	12. Actual remote control procedure	29
Accessories and Options	7	Remote Control for C4FM Digital	29
Supplied Accessories	7	Remote Control for Analog FM.....	29
Optional Accessories	7	13. Voice messages	30
Name and Function of Each Component	7	Voice Message for C4FM Digital Mode	30
Front Panel.....	7	Voice Message for Analog FM.....	30
Rear Panel	8	14. Setting the interval and number of	
1. Initial set up	9	voice messages ...	31
Turn the power on	9	15. Operate message function at	
Set up the ID (call sign).....	9	the DR-2X/DR-2XE site ...	32
2. Set up Operation Mode	10	16. Set Up Various Functions	34
3. Set up Frequency	11	Setting the half deviation operation	35
Set up Dual Receive Frequency.....	11	Setting the tone signals for analog FM mode ...	35
Select downlink antenna	12	Set the tone signal type for analog FM mode ...	36
4. Set up Priority Channel	13	Set the ID announcement for analog FM mode...	36
Priority Channel.....	13	Setting the SQL HYSTERESIS	37
5. Set up Other Functions	14	Setting the SQL TAIL LENGTH	37
Adjusting the squelch level.....	14	Setting the display turn-off time	38
Adjusting the transmit power	14	Password.....	38
Adjusting the volume	14	17. Restoring Default Settings (Factory Reset) ...	39
Turning the display ON and OFF.....	14	18. Connect to the HRI-200 node station	40
6. Base mode operation	15	19. Remote Operation with External Controller ...	42
7. Set up DG-ID Number	16	20. Installation of the Optional Accessories	47
Digital Group Identification (DG-ID) /		Installing the optional Voice Guide Unit FVS-2 ...	47
Default ID / DG-ID TOT (Time Out Timer) ...	16	21. Specifications	48
Setting the DG-ID Number	17	22. After-market Services	49
Default ID Setting	18		
Register (setting) DG-ID group.....	18		
DG-ID TOT Setting	20		

About this manual

This manual contains symbols and conventions to call attention to important information.

Symbols	Description
	This icon indicates cautions and alerts the user should be aware of.
	This icon indicates helpful notes, tips and information.
	This icon indicates other pages containing relevant information.
	This icon refers users to the Operating Manual of the IMRS function on the YAESU Website containing relevant information.

About registered trademarks and copyrights

Company and product names described in this manual are trademarks and registered trademarks of their respective companies.

Unauthorized reproduction or copying of a part or all of the copyrights owned by Yaesu Musen Co., Ltd. in any form whatsoever is strictly prohibited.

Introduction

Features of this repeater

Congratulations on your purchase of the DR-2X/DR-2XE Yaesu 144/430MHz Dual Band Dual Receive C4FM/FM Digital Repeater.

The YAESU DR-2X/DR-2XE is a C4FM digital / analog FM dual mode and dual receive repeater that covers the VHF and UHF amateur radio bands. DR-2X/DR-2XE incorporates the use of Analog FM communication integrated with the C4FM digital communication through its unique AMS capability.

- The Dual-band repeater is equipped with the VHF and the UHF Amateur radio bands.
- The AMS feature is able to relay both the C4FM and the Analog FM signals.
- The C4FM digital modes may be transferred the GPS information.
- The uplink and downlink frequencies for emergency operation may be set separately from the normally used frequency.
- Within the DG-ID feature, only the group members may communicate via the repeater.
- The DG-ID feature may be used to connect to a remote repeater via the Internet.
- Within the DG-ID feature, the system manager may control some repeater settings remotely.
- The system manager may control the priority to communicate by using the Digital Personal ID (DP-ID) feature for emergencies.
- Within the Digital Personal ID (DP-ID) feature, the system manager may record a message and the members may access the message.
- Installing the optional LAN Unit LAN-01A permits building an IMRS (Internet-linked Multi-site Repeater System) and easily managing a network of multiple connected repeaters.

About the touch panel

Precautions in using the touch panel

The touch panel of the controller is designed to work with the slightest touch of a finger.



- The touch panel may not work when a protective film or sheet is affixed to the LCD.
- Use of a pointed fingernail or pen to operate the touch panel, or pressing too hard may damage or scratch the screen.
- Smart phone operations such as flicking, pinch in and pinch out are not supported.

Safety Precautions (make sure to read these)





Make sure to read this manual in order to use this radio safely and correctly.

Note beforehand that the company shall not be liable for any damages suffered by the customer or third parties in using this product, or for any failures and faults that occur during the use or misuse of this product, unless otherwise provided for under the law.

Type and meaning of the marks

 DANGER	This mark indicates an imminently hazardous situation, which, if not avoided, could result in death or serious injury.
 WARNING	This mark indicates a potentially hazardous situation, which, if not avoided, could result in death or serious injury.
 CAUTION	This mark indicates a potentially hazardous situation, which, if not avoided, may result in minor or moderate injury or only property damage.

Type and meaning of symbols

	Prohibited actions that must not be carried out in order to use this radio safely. For example,  signifies that disassembly is prohibited.
	Precautions that must be adhered to in order to use this radio safely. For example,  signifies that the power supply is to be disconnected.

⚠ DANGER

- ⊘ Do not use the device in "locations or aircraft and vehicles where its use is prohibited" such as in hospitals and airplanes. This may exert an impact on electronic and medical devices.
- ⊘ Never touch the antenna during transmission. This may result in injury, electric shock and equipment failure.
- ⊘ Do not transmit in crowded places in consideration of people who are fitted with medical devices such as heart pacemakers. Electromagnetic waves from the device may affect the medical device, resulting in accidents caused by malfunctions.
- ⊘ Do not operate the device when flammable gas is generated. Doing so may result in fire and explosion.

- ⊘ Use good engineering, proper grounding and protective devices to protect the repeater from power surges, lightening and electrical damage via the power and external antenna connections. Otherwise when it thunders, immediately disconnect the external antenna from the repeater and shut OFF the power supply. If not, fire, electric shock and equipment failure this may result.
- ⊘ Do not touch any liquid leaking from the liquid display with your bare hands. There is a risk of chemical burns occurring when the liquid comes into contact with the skin or gets into the eyes. In this case, seek medical treatment immediately.

⚠ WARNING

- ⊘ Do not use voltages other than the specified power supply voltage. Doing so may result in fire and electric shock.
- ⊘ Do not transmit continuously for long periods of time. This may cause the temperature of the main body to rise and result in burns and failures due to overheating.
- ⊘ Do not dismantle or modify the device. This may result in injury, electric shock and equipment failure.
- 🔌 When smoke or strange odors are emitted from the radio, turn off the power and disconnect the power cord from the socket. This may result in fire, liquid leak, overheating, damage, ignition and equipment failure. Please contact our company amateur customer support or the retail store where you purchased the device.
- ⊘ Do not place the device in areas that may get wet easily (e.g. near a humidifier). This may result in fire, electric shock and equipment failure.
- ⚠ When connecting a DC power cord, pay due care not to mix up the positive and negative polarities. This may result in fire, electric shock and equipment failure.
- ⊘ Do not use power cords other than the one enclosed or specified. This may result in fire, electric shock and equipment failure.
- ⊘ Do not bend, twist, pull, heat and modify the power cord and connection cables in an unreasonable manner. This may cut or damage the cables and result in fire, electric shock and equipment failure.
- ⊘ Do not pull the cable when plugging and unplugging the power cord and connection cables. Please hold the plug or connector when unplugging. If not, this may result in fire, electric shock and equipment failure.

- ⊘ Do not handle the power plug and connector etc. with wet hands. Also do not plug and unplug the power plug with wet hands. This may result in injury, electric shock and equipment failure.
- ⚠ Keep the power plug pins and the surrounding areas clean at all times. This may result in fire, overheating, breakage, ignition etc.
- ⊘ Do not use the device when the power cord and connection cables are damaged, and when the power connector cannot be plugged in tightly. Please contact our company amateur customer support or the retail store where you purchased the device as this may result in fire, electric shock and equipment failure.
- ⊘ Do not use fuses other than those specified. Doing so may result in fire and equipment failure.
- ⊘ Do not allow metallic objects such as wires and water to get inside the product. This may result in fire, electric shock and equipment failure.
- 🔌 Disconnect the power cord and connection cables before incorporating items sold separately or replacing the fuse. This may result in fire, electric shock and equipment failure.
- ⊘ Follow the instructions given when installing items sold separately and replacing the fuse. This may result in fire, electric shock and equipment failure.
- ⊘ Do not use the device when it thunders. For safety reasons, pull the power plug out of the AC socket. Never touch the antenna as well. This may result in fire, electric shock and equipment failure due to thunder.

⚠ CAUTION

- ⊘ Do not place this device near a heating instrument or in a location exposed to direct sunlight. This may result in deformation and discoloration.
- ⊘ Do not place this device in a location where there is a lot of dust and humidity. Doing so may result in fire and equipment failure.
- ⊘ Stay as far away from the antenna as possible during transmission. Long-term exposure to electromagnetic radiation may have a negative effect on the human body.
- ⊘ Do not wipe the case using thinner and benzene etc. Please use a soft and dry piece of cloth to wipe away the stains on the case.
- ⊘ Do not put heavy objects on top of the power cord and connection cables. This may damage the power cord and connection cables, resulting in fire and electric shock.
- ⊘ Do not transmit near the television and radio. This may result in electromagnetic interference.
- ⊘ Do not use optional products other than those specified. If not, this may result in equipment failure.
- ⊘ Do not place the device on an unsteady or sloping surface, or in a location where there is a lot of vibration. The device may fall over or drop, resulting in fire, injury and equipment failure.

- 🔌 For safety reasons, switch off the power and pull out the power cord when the device is not going to be used for a long period of time. If not, this may result in fire and overheating.
- ⚠ Do not throw or subject the device to strong impact forces. This may result in equipment failure.
- ⚠ Do not put this device near magnetic cards and video tapes. The data in the cash card and video tape etc. may be erased.
- ⚠ Keep out of the reach of small children. If not, this may result in injuries to children.
- ⊘ Do not stand on top of the product, and do not place heavy objects on top or insert objects inside it. If not, this may result in equipment failure.
- ⊘ Do not use a microphone other than those specified when connecting a microphone to the device. If not, this may result in equipment failure.
- ⊘ Do not touch the heat radiating parts. When used for a long period of time, the temperature of the heat radiating parts will get higher, resulting in burns when touched.
- ⊘ Do not open the case of the product except when replacing the fuse and when installing items sold separately. This may result in injury, electric shock and equipment failure.

Setting up the Repeater

Safety measures for installation

Note the following precautions when installing this repeater:

- Use good engineering, proper grounding and protective devices to protect the repeater from power surges, lightning and electrical damage via the power and external antenna connections.
- Do not install the repeater in a place where there is extreme vibration, where there is a lot of dust, excessive humidity or high temperature, or where it is exposed to direct sunlight.
- Install the repeater in a well ventilated position, so heat dissipation is not obstructed. The heat sink becomes hot when transmitting for long periods of time.
- Do not place any objects on top of the repeater.
- Note that there is a risk that hum and noise may be introduced, depending on the installation conditions and the external power source used.

Installing the repeater

Place the repeater on a flat and level rack or shelf, with its bottom side down. We recommend securing the wings of the repeater front panel to the equipment rack or shelf with bolts.

● Mounting on rack or shelf

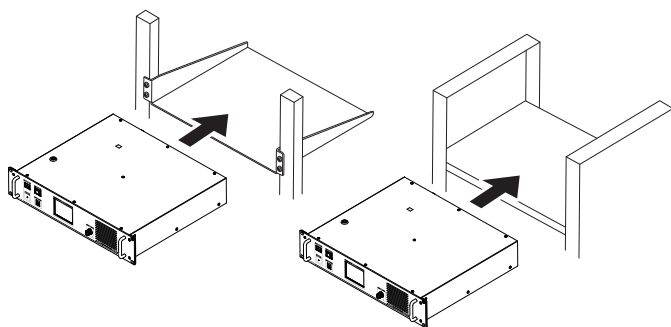

● Mounting on a desk

When using the repeater in a desktop location instead of a rack or shelf, attach the four supplied legs onto the bottom of the repeater case.

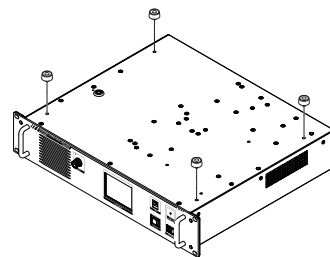

About electrical grounding

The DR-2X/DR-2XE repeater, like any other communications apparatus, requires an effective ground system for maximum electrical safety and best communications effectiveness. A good ground system can contribute to station efficiency in a number of ways:

- It can minimize the possibility of electrical shock to the operator.
- It can minimize RF currents flowing on the shield of the coaxial cable and the chassis of the repeater. Such currents may lead to radiation, which can cause interference to home entertainment devices or laboratory test equipment.
- It can minimize the possibility of erratic repeater/ accessory operation caused by RF feedback and/or improper current flow through logic devices.

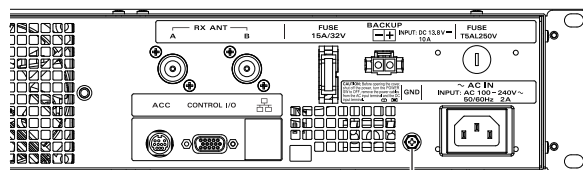

To prevent damage from lightning, atmospheric electricity, electrical shock, etc., provide a good earth ground. Use a short, thick, braided cable to connect your station equipment to the buried ground rod (or alternative earth ground system).

The figure above shows the rear panel of the DR-2X.

Connecting Antenna Cables

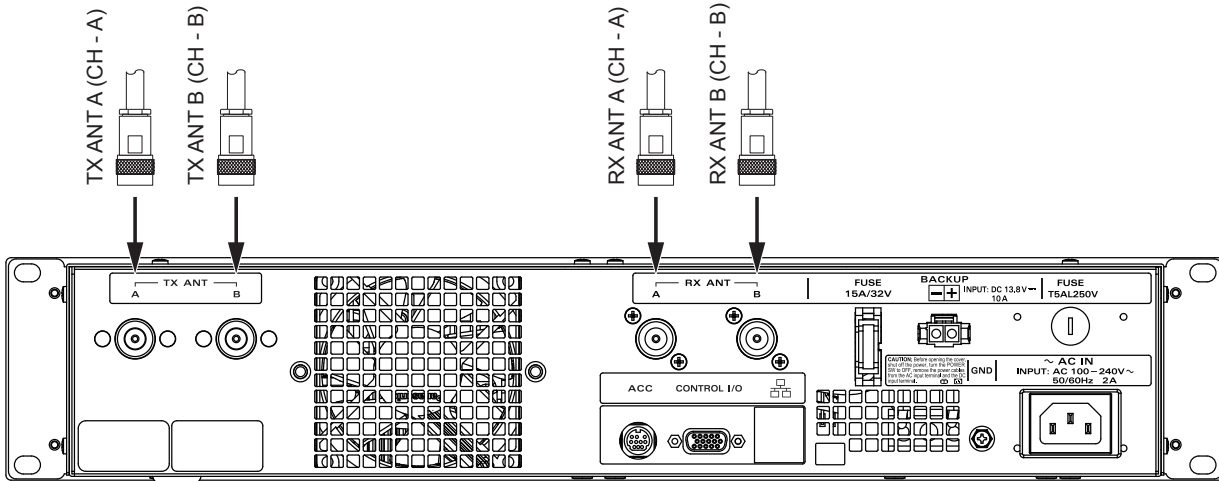

The figure above shows the rear panel of the DR-2X.

- 1 When using a duplexer, plug the coaxial cables from the TX ANT and RX ANT terminals into the jacks of the duplexer, and tighten the connectors.
- 2 Plug in the terminal of the coaxial cable connected to the antenna into the jack of the duplexer, and turn to tighten.

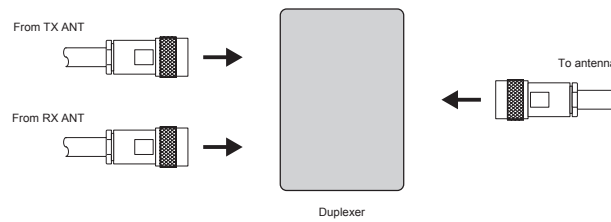

Select downlink antenna

Normally, the CH-A downlink outputs to the CH-A TX Antenna Terminal and the CH-B downlink outputs to CH-B TX Antenna Terminal. Both CH-A and CH-B downlinks may be output to the CH-A TX Antenna Terminal. This setting allows operating both downlinks with the same antenna.

By pressing and holding "DOWNLINK" in the CH-B frequency set up screen, "DOWNLINK" will be changed to "DOWNLINK TO ANT A" and the CH-B downlink signal will be output to CH-A (see page 12).

Connecting the Power Supply

Connection for DR-2X (US and Asian versions)

● Main power



Use an AC outlet capable of supplying AC 100-240V at 50 or 60Hz.

- 1 Insert the socket of the provided AC power cord into the AC IN jack at the rear of the repeater.
- 2 Insert the plug of the provided AC power cord into the AC outlet.

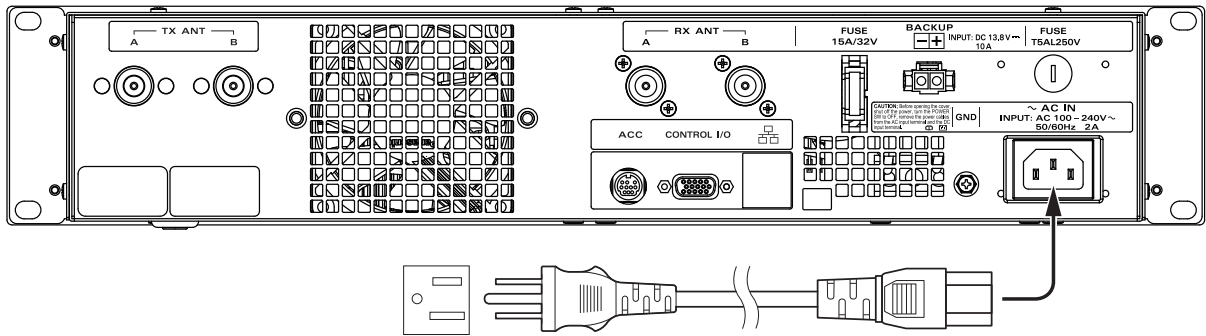

● Backup power

For uninterrupted operation during power failures, a 13.8V rechargeable automotive type battery (55-Ah or more recommended) may be connected to the BACKUP terminal posts on the rear panel. In the event of an AC power outage, the automatic power control circuit will switch the repeater to the backup battery, and operation will not be interrupted.

While operating from a battery or DC supply, the repeater requires approximately 14A at 13.8V during transmit.

Always observe proper polarity when making DC connections.

- Use a power source capable of supplying DC 13.8V and a current capacity of 14A or more.
- Make sure to switch OFF the power of the external power source before connecting.
- If the transmit power is set to "HI" (50W), the transmit power is automatically set to "MD" (20W) when operation is switched to the backup power supply.
- The repeater is not designed to charge depleted batteries, as their current requirements will be too great. Use of a properly designed, regulated charging circuit is required.



- 1 Insert the connector of the provided DC power cord into the BACKUP jack at the rear of the repeater.
- 2 Connect the red wire (+) of the provided DC power cord to the positive (+) terminal of the external power source, and the black wire (-) to the negative (-) terminal.

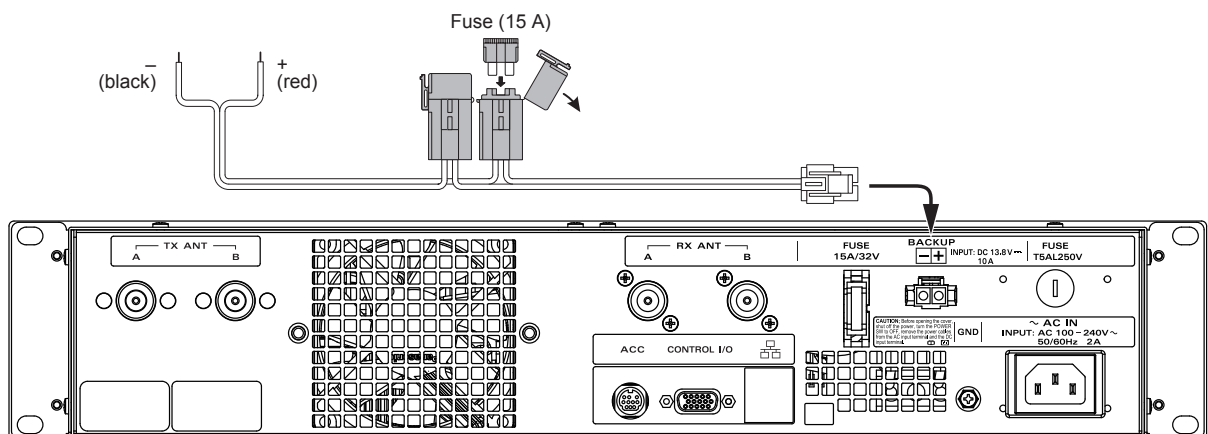

Connection for DR-2XE (European and Australian versions)

Follow the outline in the illustration regarding the proper connection for the required External Power Supply. The DC power connector for the DR-2XE must only be connected to a DC source providing 13.8V DC ($\pm 15\%$), and capable of at least 10A of current.

Always observe proper polarity when making DC connection.



Make sure to switch OFF the power of the external power source before connecting.

- 1 Insert the connector of the provided DC power cord into the DC IN jack at the rear of the repeater.
- 2 Connect the red wire (+) of the provided DC power cord to the positive (+) terminal of the external power source, and the black wire (-) to the negative (-) terminal.

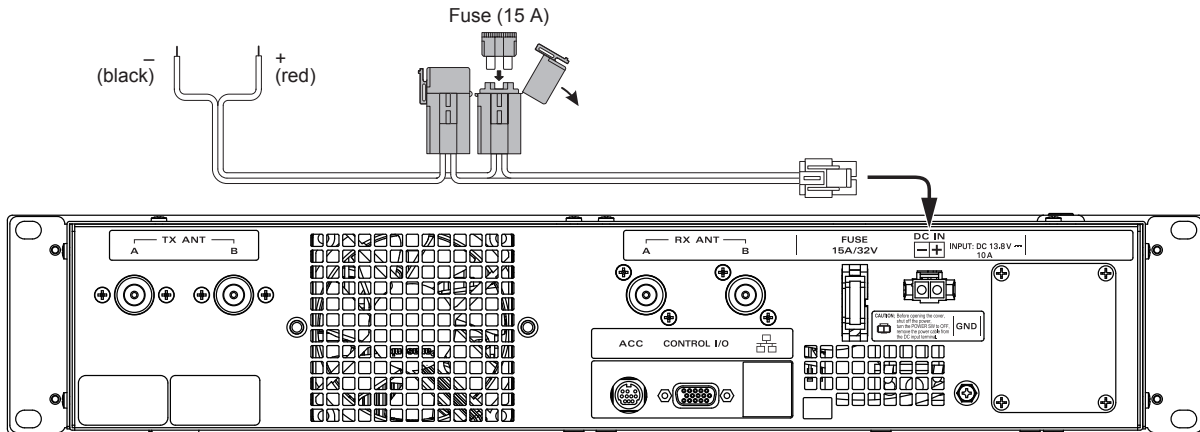

The external power source should be installed near the equipment and should be easily accessible.



Permanent damage can result when improper supply voltage, or reverse-polarity voltage, is applied to the DR-2XE. The Limited Warranty on this radio does not cover damage caused by application of AC voltage, reverse polarity DC, or DC voltage outside the specified range of 13.8 V $\pm 15\%$. When replacing fuses, be certain to use a fuse of the proper rating. The DR-2XE requires a 15A blade fuse.

Connecting External Devices

Connection of an external microphone

By connecting an optional microphone MH-48A6JA or MH-42C6J to the [MIC] jack on the front panel, voice communications are possible in the mode which is set on the transmitter. Except when AMS is set on the transmitter, data transmission is not available via the [MIC] jack.

Connection to a personal computer

The supplied PC connection cable "SCU-20" can be used to connect the repeater to a personal computer as a USB port.

Use the [ACC] jack to connect with the optional WIRES-X Internet Linking Kit "HRI-200".

The pin assignments of the [ACC] jack are as follows.

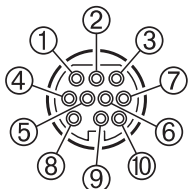

- | | |
|---|--|
| ① PKD (packet data input) | ⑥ PK SQL (squelch control) |
| ② GND | ⑦ TXD (serial data output [repeater → PC]) |
| ③ PKS (PTT) | ⑧ RXD (serial data output [repeater ← PC]) |
| ④ RX 9600 (9600 bps packet data output) | ⑨ CTS (data communication control) |
| ⑤ RX 1200 (1200 bps packet data output) | ⑩ RTS (data communication control) |



- Make sure to switch off the power to the radio before connecting the cable.
- When using the SCU-20, PC connection cable, a dedicated driver must be installed in the personal computer. Download and use the driver and installation manual from the YAESU website.

Accessories and Options

Supplied Accessories

AC Power Cord (T9027682)*1	1
DC Power Cord with Fuse (T9026115)	1
Spare Fuse 15 A (Q0000075)	1
5 A (Q0000143)*1	1
Case Legs (S4000052)	4
PC Connection Cable SCU-20	1
Operating Manual (this manual)	1
Warranty Card	1

*1: For DR-2X only

Optional Accessories

DTMF Microphone	MH-48A6JA
Hand Microphone	MH-42C6J
Voice Guide Unit	FVS-2
LAN Unit	LAN-01A

Name and Function of Each Component

Front Panel

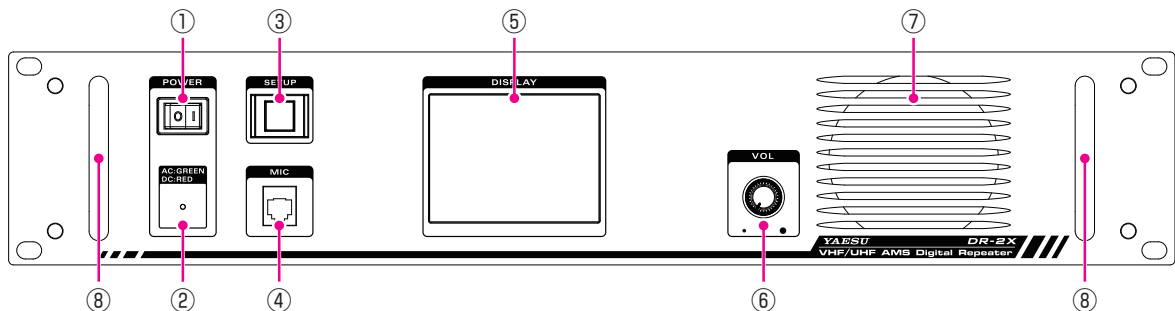

- POWER Switch**
Press "I" side to switch the repeater ON, and "O" side to switch the repeater OFF.
- LED Indicator**
 - When the indicator illuminates in green, the power is supplied from the AC IN jack (DR-2X only).
 - When the indicator illuminates in red, the power is supplied from the DC IN terminals (DR-2XE) or BACKUP terminals (DR-2X).
- SETUP Button**
Press and hold to switch the display ON and OFF.
When a display is OFF, operation of a touch panel will be locked.
- MIC Jack**
Insert the plug of the optional microphone MH-48A6JA or MH-42C6J to this 6-pin modular jack.
- Touch Panel Display**
- VOL Knob**
The VOL knob adjusts the audio volume level of the received (uplink) signal and the beep sound.
- Speaker**
The internal speaker is located here.
- Handle**

Rear Panel

○ DR-2X (US and Asian versions)

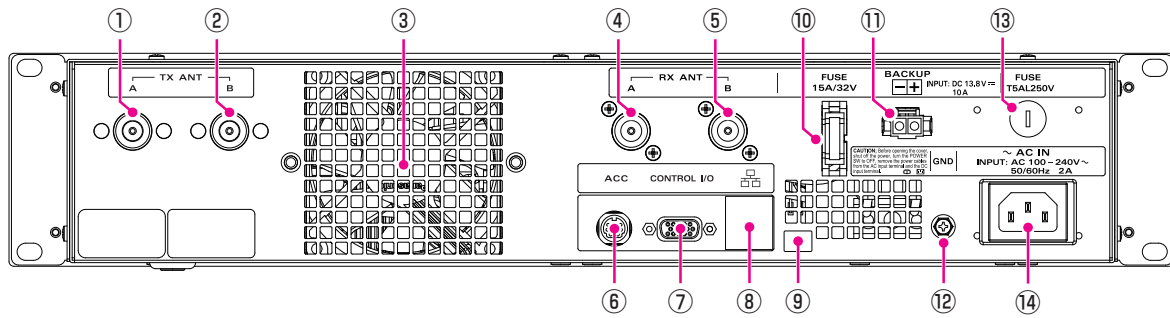

○ DR-2XE (European and Australian versions)

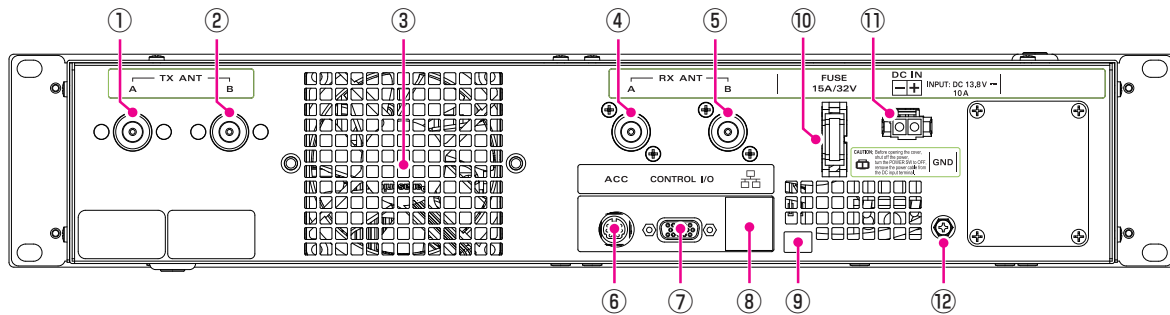

- ① **CH-A TX Antenna Terminal** (N-type connector, 50 ohms)
Connect to the transmitting antenna (downlink of the CH-A) with the coaxial cable.
Both CH-A and CH-B downlinks may be transmitted from this antenna terminal (see page 12).
- ② **CH-B TX Antenna Terminal** (N-type connector, 50 ohms)
Connect to the transmitting antenna (downlink or emergency TX channel of the CH-B) with the coaxial cable.
- ③ **Cooling fan**
- ④ **CH-A RX Antenna Terminal** (N-type connector, 50 ohms)
Connect to the receiving antenna (uplink of the CH-A) with the coaxial cable.
- ⑤ **CH-B RX Antenna Terminal** (N-type connector, 50 ohms)
Connect to the receiving antenna (uplink or control RX channel of the CH-B) with the coaxial cable.
- ⑥ **ACC Jack**
Connect to a HRI-200 WIRES-X Interface Unit or a personal computer with the provided PC connection cable "SCU-20".
- ⑦ **CONTROL I/O Connector**
This connector allows the repeater to be connected to an external controller for remote operation.
- ⑧ **LAN Connector**^{*1} (Requires Optional LAN-Unit LAN-01A)
This connector is for linking repeaters via the Internet.
- ⑨ **micro USB Connector** (Requires Optional LAN-Unit LAN-01A)
This connector is for the setup of the LAN-Unit.
- ⑩ **FUSE Holder (15A/ 32V)**
A 15A fuse for the DC power supply through the BACKUP / DC IN jack is attached.
- ⑪ **Power Supply BACKUP Jack (DR-2X) / DC IN jack (DR-2XE)**
Connect to a 13.8V DC power supply with the supplied DC power cord.
- ⑫ **GND Terminal**
- ⑬ **FUSE Holder (DR-2X only)**
A 5A fuse for the AC power supply through the AC IN jack is attached.
- ⑭ **AC IN Jack (DR-2X only)**
Connect to a 100-240V AC line outlet with the supplied AC power cord.

1. Initial set up

Turn the power on

- 1 Press the POWER switch.

The power will be switched ON, and the power supply monitor (LED indicator) will illuminate.



- When the power is supplied from the AC IN jack, the indicator illuminates in green (DR-2X only).
- When the power is supplied through the BACKUP terminals / DC IN terminal (13.8V DC), the indicator illuminates in red.

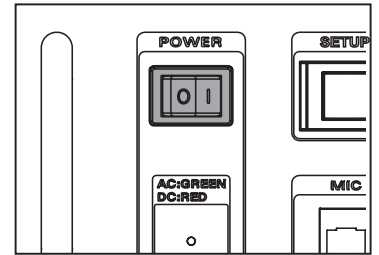

The operation mode screen will appear on the display.

Set up the ID (call sign)

The call sign or ID must be entered for the first time after purchasing, or after resetting the repeater.



After performing a factory reset, the ID call sign setup begins with 2.

- 1 Touch [A SETUP] or [B SETUP] to display Frequency screen.

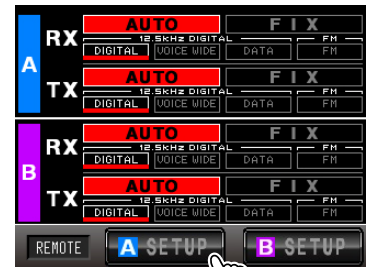

- 2 Touch [F] to display the Function screen pops up.

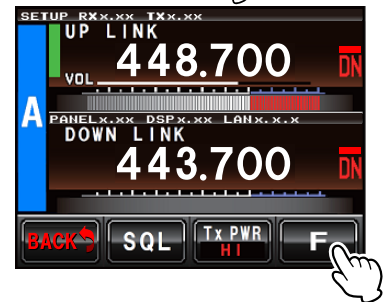

- 3 Touch ID set area.

The character input screen will appear.



- 4 Touch a character key.

The touched character will be displayed at the top of the screen.



- Each time [X] is touched the cursor will move to the left and erase one character.
- The input screen changes between numbers input and alphabet input each time [ABC] is touched.
- The cursor in the input field moves left or right when [←] or [→] are touched.
- Up to 10 alphabet characters, numbers, or the hyphen can be entered.

- 5 Touch [ENT].

The ID setting is saved and the display will return to the Function screen.

2. Set up Operation Mode

When the Power Switch is turned ON, Operation Mode screen appears.

This screen is for normal operation.

The DR-2X/DR-2XE could be set up with two frequencies for the uplink and the downlink and also different operation modes for each frequency.

Normal Dual CH Operation

In Normal Dual Channel Operation, the DR-2X/DR-2XE accepts the uplink channel on a first come basis, and the later signal on the other channel is not repeated until the first channel is released.

Priority Dual CH Operation

In Priority Dual Channel Operation, the DR-2X/DR-2XE always repeats the Priority Channel, regardless of any signals on the other channel (see page 13 "Priority Channel").

To setup priority CH, touch the area between RX and TX on the channel you want to set the priority channel. To reset, touch the area again.

Single CH Operation

If you do not need the second CH on DR-2X/DR-2XE, just enter any frequency on CH-B and do not connect the uplink antenna to RX ANT B.

CH-B can be used exclusively for repeater control without any repeater operation. In this case, the downlink frequency of CH-B is not displayed.

To setup CH-B for control only, touch the area between RX and TX on the CH-B until CNTL appears.

To reset, touch the area again.



To receive Analog FM and Digital C4FM signals simultaneously, set RX to [AUTO] mode.

This mode may activate the AMS (Automatic Mode Select) function, then receive (uplink) and transmit (downlink) signals of the Analog FM and Digital C4FM. The default setting is [AUTO].

If operating the repeater using the DG-ID and connecting multiple repeaters, select the [DIGITAL] in the [FIX] mode. The DG-ID function is not available because the Analog FM mode does not include the DG-ID information.

In the C4FM digital mode, three digital modes are recognized automatically. In normal C4FM digital, it will be in V/D mode.

- ① Touch [AUTO] or [FIX] in the operation mode screen area to set the operating mode.
 - [AUTO] Touch here to activate the AMS function. The mode switches automatically according to the received/transmitted signal types. [AUTO] is turned red, [DIGITAL] automatically light up.
 - [FIX] Touch here to activate the FIX mode. [FIX] is turned yellow. Note that when selecting the [FIX] mode, that other mode signals may not be received.
- ② Either [VOICE WIDE] or [DATA] modes are automatically recognized in the C4FM uplink Signal, and receive mode is changed to fit the signals, so no setting is necessary.

[DIGITAL]	Normal C4FM digital mode
[VOICE WIDE]	High-rate voice C4FM digital mode
[DATA]	High-speed data C4FM digital mode
[FM]	Analog FM communication mode

- ③ **RX** indicator This indicator shows green when a signal is received and white when there is no signal.
 - TX** indicator This indicator shows red when the repeater transmits and white when there is no transmit.
 - PRI** indicator This indicator shows when the channel is set to the Priority Channel.
 - CNTL** indicator This indicator shows when CH-B is set as the dedicated control channel, and it does not repeat.
- ④ **[REMOTE]** Displayed in red when remote operation with an external controller is enabled (see page 42).
 Displayed in red (blinks) when optional LAN Unit LAN-01A is enabled.
 - [A SETUP]** Touch here to switch the display to set up the frequency on CH-A.
 - [B SETUP]** Touch here to switch the display to set up the frequency on CH-B.

3. Set up Frequency

Set up Dual Receive Frequency

DR-2X/DR-2XE is equipped with dual receive feature that may receive two different frequencies in the VHF and the UHF Band of Amateur radio bands, so the other uplink and downlink frequency for emergency communications may be set separately from the normally used frequency.

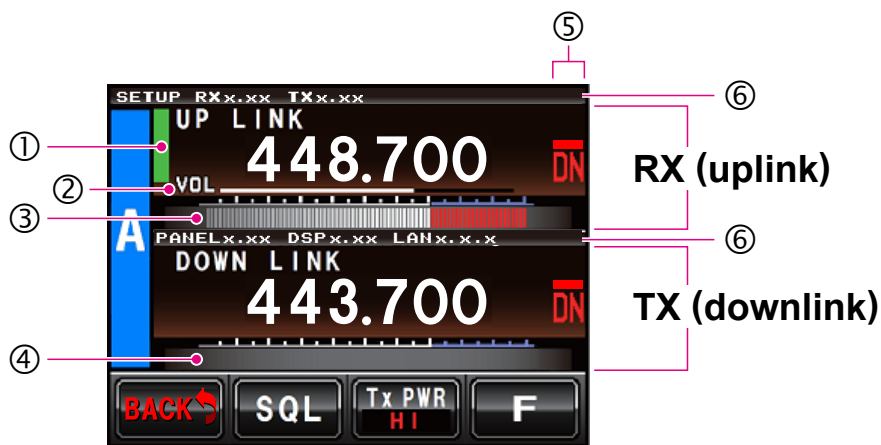

- ① Status display area
 A green bar is displayed during receive when signals are detected.
 The bar will not be displayed when the squelch is turned on and the received signal level is below the squelch level.
- ② VOL/SQL level display
- ③ S-meter level display
- ④ PO-meter level display
- ⑤ Mode display
- ⑥ Firmware Version Information
 RX x.xx: RX-UNIT CPU Firmware Version
 TX x.xx: TX-UNIT CPU Firmware Version
 PANEL x.xx: PANEL-UNIT CPU Firmware Version
 DSP x.xx: DSP-UNIT CPU Firmware Version
 LAN x.xx: LAN-UNIT CPU Firmware Version

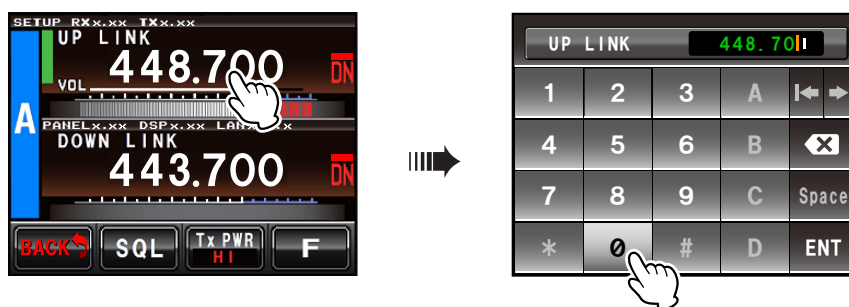

Touch **[A SETUP]** to display the CH-A frequency set up screen, then set the uplink and downlink frequency. Touch the uplink frequency of CH-A, the numeric input popup screen appears. Input the uplink frequency.

After completing the input frequency, the input popup screen automatically disappears and the input frequency is set.

Input the downlink frequency in the same way.

Touch **[Back]** to return to the operation mode screen, and touch **[B SETUP]** on the bottom of the screen to display the CH-B frequency set up screen, then set the uplink and downlink frequency.

Even if the CH-A and CH-B uplinks are set to different frequencies, setting the downlink to the same frequency, makes it possible for all members to hear the conversation at the same downlink frequency whatever the uplink frequency is used.

Select downlink antenna

Normally, downlink of CH-A outputs to the CH-A TX Antenna Terminal and the downlink of CH-B outputs to the CH-B TX Antenna Terminal. Both CH-A and CH-B downlinks may output to the CH-A TX Antenna Terminal. This setting allows to operating the downlink frequency with the same antenna.

How to set up the downlink antenna terminal:

- 1 Touch **[B SETUP]** to display the CH-B frequency set up screen.
The setup mode screen will appear.
- 2 Press **"DOWN LINK"** in the CH-B frequency set up screen, **"DOWN LINK"** will be changed to **"DOWN LINK TO ANT-A"** and CH-B downlink signal will be output to CH-A.

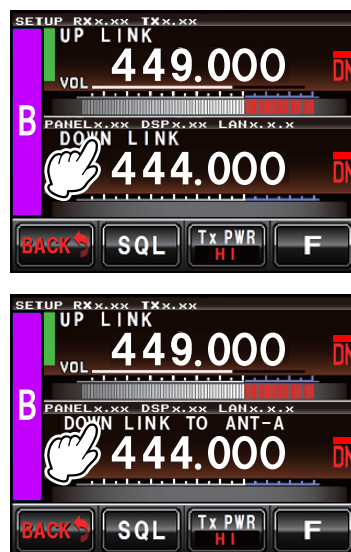

Since the DR-2X/DR-2XE has only one transmitter, even if the downlink frequency is set separately, the signal will not be transmitted simultaneously.

4. Set up Priority Channel

Priority Channel

In the dual receive function, one channel may be set as the priority channel.

Normal operation mode:

- When CH-A and CH-B are set to different uplink frequencies, a signal on either uplink frequency will inhibit reception on the other channel until the first channel communication is complete.

Priority mode:

- When receiving a signal on the channel set as Priority, even if communication is in progress on the normally used frequency, that communication will be stopped and the emergency (Priority) communication will be automatically transmitted.

To set the priority channel, touch [RX]/[TX] area of the prioritized channel in the operation setup screen, "PRI" appears and this channel is set to the Priority channel.

To deactivate the Priority channel, touch the same area to unset PRI and return to normal operation.

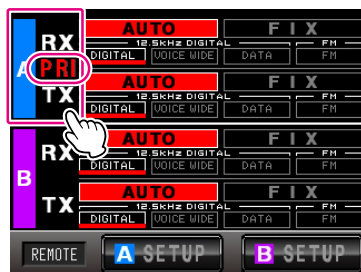

Priority mode

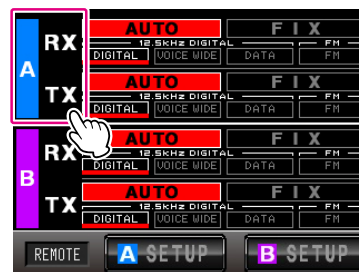

Normal operation mode



The uplinks may be received simultaneously, but since the DR-2X/DR-2XE has only one transmitter, even if the downlink frequency is set separately; the signals may not be transmitted simultaneously.

In the FIX (Digital C4FM) mode, when CH-A or CH-B is set to Priority, a received C4FM digital signal including the registered DG-ID will have precedence over signals received on the other channel.

In the AUTO mode, this channel will have precedence when receiving a C4FM digital signal including the registered DG-ID or when receiving an FM signal including the registered CTCSS.

Transmissions are not interrupted, even if other signals are received on the priority channel.

5. Set up Other Functions

Adjusting the squelch level

- When the squelch level is set to “open” the repeater will transmit, so the TX output must be connected to the duplexer and antenna.
- Use extreme caution when making the squelch adjustment or measurement with a signal generator. Do not connect the signal generator to the duplexer antenna port. To avoid damage to the test equipment, always connect the signal generator directly to the RX antenna connector on the DR-2X/DR-2XE.
- While the squelch level is being set, repeater transmit operation is temporarily permitted. This will facilitate checking the performance of the Duplexer, and allow evaluation of the receiver sensitivity degradation (“desense”), during simultaneous transmit/receive operation.



- 1 Touch **[A SETUP]** or **[B SETUP]**.
The setup mode screen will appear.
- 2 Touch **[SQL]**.
When **[SQL]** turns yellow, the VOL meter below the RX band frequency display, will change to the SQL meter and show the squelch level setting.
- 3 Touch **[▲]** or **[▼]** to adjust the squelch level.
The level will be displayed in the SQL meter.
- 4 Touch **[BACK]**.
The squelch level is set, and the display will return to the operation mode screen.

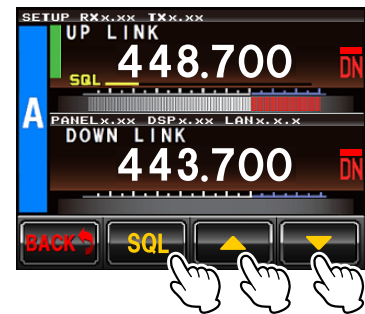

Adjusting the transmit power

- 1 Touch **[A SETUP]** or **[B SETUP]**.
The setup mode screen will appear.
- 2 Touch **[Tx PWR]** to select the transmit power.
The setting is changed in the following sequence, each time **[Tx PWR]** is touched.
“HI” → “LO” → “MD” →

HI	MD	LO
50 W	20 W	5 W

- 3 Touch **[BACK]**.
The transmit power level is set, and the display will return to the operation mode screen.

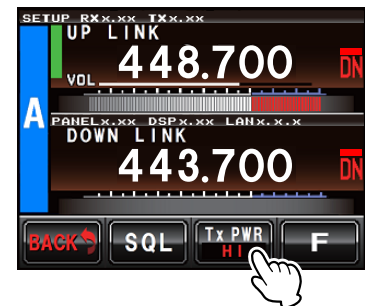

Adjusting the volume

Turn the VOL knob.

The VOL knob adjusts the audio volume level of the received (uplink) signal.

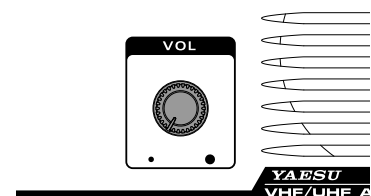

Turning the display ON and OFF

- 1 Press and hold the **SETUP** button to turn the display OFF.
When a display is OFF, operation of the touch panel will be locked.



The display will turn OFF automatically after a period of time (default 1 min) with no operation.

The display duration time setting may be selected from “1min”, “5min”, “10min”, or “30min” (see page 38 “Setting the display turn-off time”).

- 2 Press and hold the **SETUP** button for 3 seconds to turn the display ON.

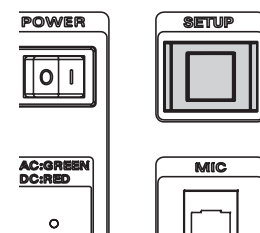

6. Base mode operation

The repeater can be used as a VHF/UHF base station by connecting an optional MH-48A6JA or MH-42C6J microphone to the “**MIC**” jack on the front panel.



The base mode operation is available only on CH-A.

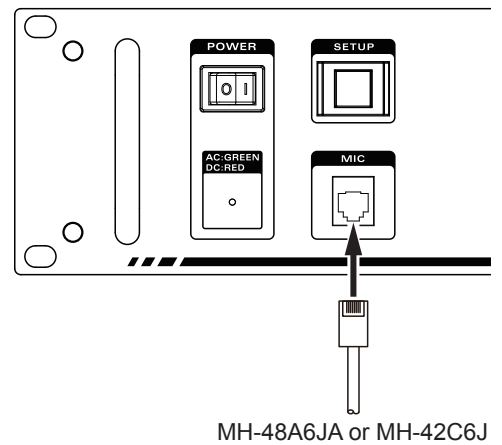

7. Set up DG-ID Number

Digital Group Identification (DG-ID) / Default ID / DG-ID TOT (Time Out Timer)

The Digital Group Identification (DG-ID) feature controls access to the repeaters by using the two-digit numbers from 01 to 99, and permits management of multiple repeaters (IMRS) connected via the Internet. This feature is similar to the CTCSS function used in the Analog FM mode.

The DG-ID number 00 detects signals with all ID numbers.

The default DG-ID number is set to "00". All the C4FM digital stations' uplink signal may be operated.

- If operating this repeater using the DG-ID and connecting the multiple repeaters, select the FIX DIGITAL mode in the operation mode screen. The DG-ID function is not available because the Analog FM mode does not include the DG-ID information.

In order to use the DG-ID feature, update the C4FM digital transceivers to the latest firmware compatible with the DG-ID feature.

- The latest firmware for each transceiver is available on the YAESU website.
- The DR-2X/DR-2XE will repeat on the downlink, only the uplink signals with the corresponding DG-ID number if the DG-ID number is set to an arbitrary number from "01" to "99", (other than "00". and signals with a different DG-ID number will not transmit on the downlink.
- If the DG-ID number is set to "00", all the C4FM digital signals are transmitted on the downlink.

● GROUP DG-ID

Using the TOT (Time Out Timer) feature of the Group DG-ID

When connecting multiple DR-2X/DR-2XE repeaters via the Internet, the DR-2X/DR-2XE repeaters may be grouped to operate only with the repeaters of the area that wish to communicate. Therefore, the repeaters that are not grouped do not transmit an unnecessary downlink signal. Also, the repeaters that are not grouped together may be used by other transceivers.

In using this convenient feature, the DG-ID TOT (Time Out Timer) allows temporary intercommunication between all the grouped repeaters by canceling the grouped state of each repeater for a certain period of time. If the DG-ID TOT is set in advance, the grouped repeaters are connected only for the set time.

The signal from the other station may also be transmitted on the downlink signal and communicated.

While activating the TOT (Time out timer), the grouped state of the repeaters is cancelled and the repeater may be used. To communicate by using the DG-ID, wait until the DG-ID TOT (Time Out Timer) times out.

If the repeater may not be accessed because of the TOT operation, or because it is in use, the following beep sounds are emitted to notify.

The beep sound (1 time): The TOT is activated and accessed by DG-ID number other than the default DG-ID.

The beep sound (2 time): Notifies all repeaters downlink that the TOT has timed out.

The beep sound (3 time): Notifies the repeater may not be accessed because the other repeater is in use.

● How to use the DEFAULT ID

The default DG-ID is convenient for operating with a multiple group of repeaters. Normally, set your transceiver DEFAULT ID to the same DG-ID number as set in the repeater. Normally, the DG-ID number and default DG-ID number are set to the same number.

Normally, the DEFAULT ID has the same local ID number, but it can also be used as follows.

When activating the DG-ID TOT (Time Out Timer), all the other DG-ID communications group are also locked groups. Wait until the DG-ID TOT (Time Out Timer) setting is timed out before communicating with the other DG-ID.

Therefore, in such a case, if you always set the group DG-ID to be used in such a case to DEFAULT DG-ID, the DG-ID TOT (Time Out Timer) does not work with DEFAULT DG-ID. You can immediately move to another group DG-ID without waiting until the lock-up time is over.

Setting the DG-ID Number

- 1 Touch **[A SETUP]** or **[B SETUP]** to display the frequency set up screen, then touch **[F]** on the bottom of the screen.
- 2 Keep touching **[ID MODE]** (DG-ID).
The DG-ID list screen appears.

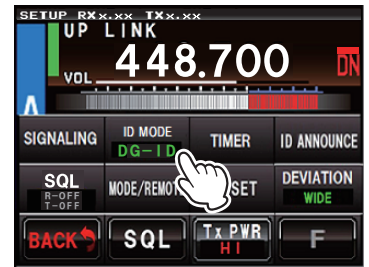

- 3 Touch **[LOCAL RPT]**.
The LOCAL RPT DG-ID screen appears.



- 4 Touch **[▲]** or **[▼]** to select the desired DG-ID number to be registered to the DR-2X/DR-2XE repeater.



When using the DR-2X/DR-2XE as an Open Repeater that anyone may use, set the DG-ID to "00".

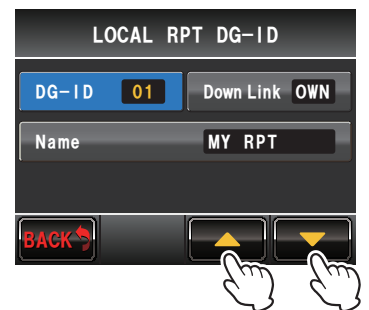

- 5 Touch **[Name]** twice.
The character input screen appears.



- 6 Input the name to be registered to the DR-2X/DR-2XE repeater.



Up to 10 characters may be input.

- 7 Touch **[ENT]**.
The input characters are registered and operation returns to the LOCAL RPT DG-ID screen.
- 8 Touch **[BACK]** 4 times.
The screen returns to the operation mode screen.

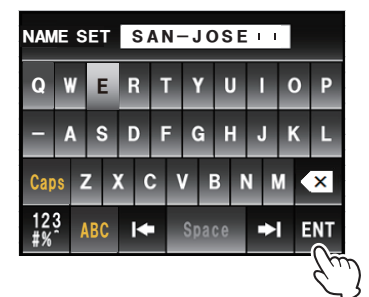

Default ID Setting

- 1 Touch **[A SETUP]** or **[B SETUP]** to display the frequency set up screen, then touch **[F]** on the bottom of the screen.
- 2 keep touching **[ID MODE]** (DG-ID).
The DG-ID LIST screen appears.
- 3 Touch **[Group]** twice.
The Group DG-ID setting screen appears.
- 4 Touching **[DG-ID]** switches between “gray” and “blue”, then select “blue”. (Gray = normal DG-ID, Blue = Default ID)
- 5 Touch **[BACK]**.
The screen returns to the DG-ID list screen.
- 6 Touch **[BACK]** 3 times.
The screen returns to the operation mode screen.

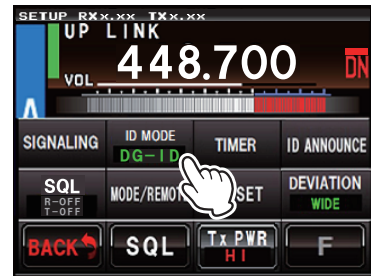

Register (setting) DG-ID group

- 1 Touch **[A SETUP]** or **[B SETUP]** to display the frequency set up screen, then touch **[F]** on the bottom of the screen.
 - 2 keep touching **[ID MODE]** (DG-ID).
The DG-ID list screen appears.
 - 3 Touch an unregistered **[Group DG-ID]** twice.
The Group DG-ID setting screen appears.
 - 4 Touch **[DG-ID]**.
The default DG-ID may be set in Set Group DG-ID. Touch DG-ID to change the Setting to default DG-ID, the blue screen. Verify that DG-ID is set to default DG-ID.
-  Touching **[DG-ID]** switches between “gray” and “blue”, select “blue”. (Gray = Normal DG-ID, Blue = Default DG-ID) (The TOT does not work on an uplink signal that includes the same DG-ID)
- 5 Touch **[▲]** or **[▼]** to select the desired DG-ID number and register it to the Group.

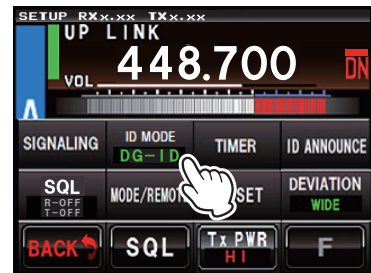



Steps 6 to 10 are the procedures to enable listing the DG-ID of the repeaters to be linked. If the list display is not required, go to step 11.

6 Touch **[Registered DG-ID]** twice.

The registration screen of the repeater to be linked as a group is displayed.



7 Touch **[EDIT]**.

The DG-ID input screen appears.



8 Enter the DG-ID number of all repeaters to be linked as a group.

9 Touch **[BACK]**.

The DG-ID list screen appears.

10 Touch **[BACK]**.

The DG-ID setting is saved and the display will return to Group DG-ID setting screen.

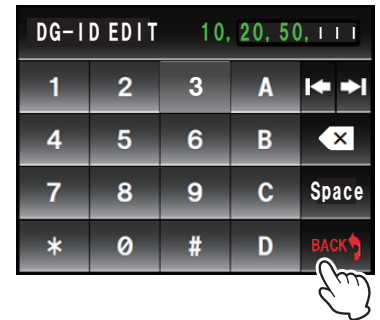

11 Touch **[Group name]** twice.

The character input screen appears.



12 Input the name to be registered to the Group.



Up to 10 characters may be input.

13 Touch **[ENT]**.

The Group name setting is saved and the display will return to Group DG-ID setting screen.

14 Touch **[BACK]** 4 times.

The screen returns to the operation mode screen.



DG-ID TOT Setting

Setting accessible time of the other DG-ID other than the Default DG-ID.

- 1 Touch **[A SETUP]** or **[B SETUP]** to display the frequency set up screen, then touch **[F]** on the bottom of the screen.
- 2 Touch **[TIMER]**.

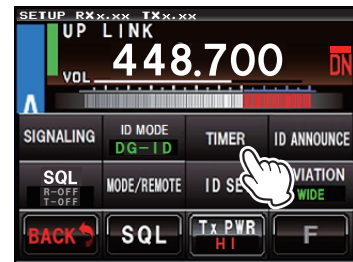

- 3 Touch **[TOT]**.

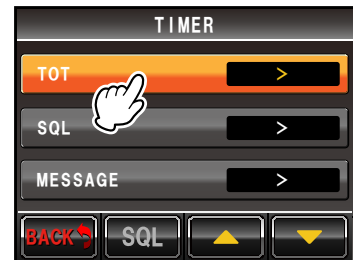

- 4 Touch **[IMRS TOT]**.
- 5 Touch **[▲]** or **[▼]** to select TOT time.
Selectable from 0/30sec/1min/1.5min/2min/2.5min/3min/4min/5min/10min/CONT.



The default setting is 1 min.

- 6 Touch **[BACK]** 4 times.
The screen returns to the operation mode screen.

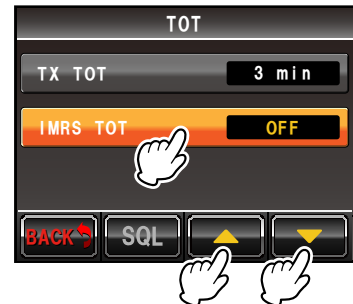

8. Set up DP-ID

Digital Personal Identification (DP-ID)

Digital Personal Identification (DP-ID) is the digital ID number each transceiver is programmed with. The system manager may operate the DR-2X/DR-2XE repeater functions, and the emergency communication, by registering the DG-ID number of the controlling C4FM digital transceiver to the DR-2X/DR-2XE.

When receiving the uplink signal containing the DP-ID that is registered to the DR-2X/DR-2XE, the signal is received and transmitted on the downlink preferentially. In addition, if connecting multiple repeaters via the Internet, signals containing the registered DP-ID will be transmitted on the multiple repeater downlinks (the local repeater signals may also be transmitted on the downlink.).

● DP-ID feature

Emergency Transmission Feature

When the DR-2X/DR-2XE receives a signal from a transceiver with a registered DP-ID, the DR-2X/DR-2XE operates in preference to all operations.

When the repeater DP-ID setting is ON, the signal containing a DP-ID from a C4FM transceiver may be registered in the repeater DP-ID log.

- 1 Touch **[A SETUP]** or **[B SETUP]** to display the frequency set up screen, then touch **[F]** on the bottom of the screen.
- 2 Touch **[ID MODE]** to select the “DP-ID”.

Touching **[ID MODE]** switches the setting as follows:

DP-ID → DG-ID → DP-ID →



The DP-ID display returns to the DG-ID display in about 5 seconds.

- 3 Keep touching **[ID MODE]** (DP-ID) for more than two seconds. The DP-ID list screen appears.
- 4 Touch **[REG]**. The Registration Confirmation Screen appears for about 5 seconds.
- 5 Tune the registering transceiver to the repeater frequency, then transmit in the C4FM mode.
 - The call sign and Radio ID from the received transceiver are displayed.

- 6 Touch **[OK?]** to register Radio ID, or touch **[Cancel]** to return to the DP-ID list screen without registering.
 - If registering another transceiver, repeat step 4 to 6.



Up to 30 DP-ID information data may be registered.

- 7 Touch **[BACK]** 3 times. The screen returns to the operation mode screen.

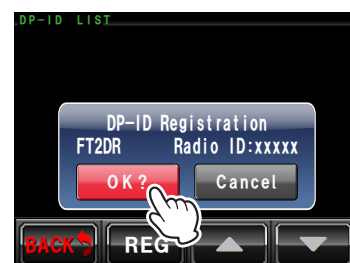
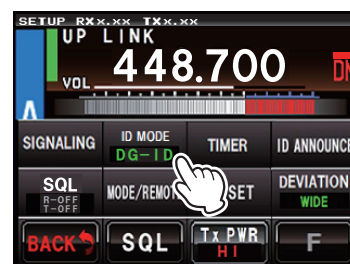

● **Delete the registered DP-ID**

1 Touch **[A SETUP]** or **[B SETUP]** to display the frequency set up screen, then touch **[F]** on the bottom of the screen.

2 Touch **[ID MODE]** to select the “DP-ID”.

Touching **[ID MODE]** switches the setting as follows:

DP-ID → DG-ID → DP-ID →



The DP-ID display returns to the DG-ID display in about 5 seconds.

3 Keep touching **[ID MODE]** (DP-ID) for more than two seconds. The DP-ID list screen appears.

4 Touch the desired DP-ID to delete.

DELETE (Deletion Confirmation Screen) appears.

5 Touch the **[OK?]** to delete or touch the **[Cancel]** to return to the DP-ID list screen without deleting.

- If deleting another transceiver, repeat step 4 to 5.

6 Touch **[BACK]**.

The screen returns to the setup screen.

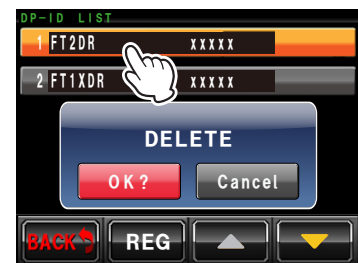
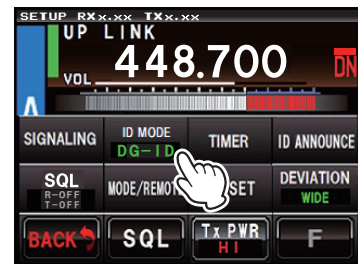

- If using the DP-ID, select the FIX Digital mode in the operation mode screen. When transmitting the DP-ID signal, set the transceiver to C4FM mode.

The system manager may control the repeater setting remotely from designated transceivers by using this function.

The transceivers compatible with the remote-control is the FTM-400D, FTM-400XD, FTM-100D and FTM-3200D.

Example:

- Sets the repeater function ON or OFF (only the locally connected repeater, or all the linked repeaters)
- Changing Downlink Transmission Power
- Recording / Playing / Clearing the Voice Message
- Setting of the Emergency Call

9. [Example] Basic Set up and Operations

Stand Alone Operation

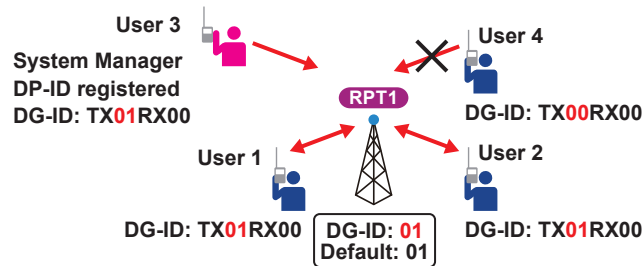

Setting Content (Frequencies are shown for example only, use your repeater coordinated frequencies)

CH-A	RX	AUTO AMS	448.700 MHz
	TX	AUTO AMS	443.700 MHz
CH-B PRIORITY ON	RX	FIX DIGITAL	449.000 MHz
	TX	FIX DIGITAL	444.000 MHz
DG-ID: 01			
DEFAULT ID: 01			
DP-ID: The system manager USER-3 has registered the DP-ID			

- The group members, USER-1, USER-2 and USER-3 have set the transmit DG-ID to 01 and the receive DG-ID to 00.
- The system manager, USER-3 knows the uplink frequency of CH-B. The group members USER-1 and USER-2 know only the normal uplink frequency of CH-A.
- USER-4 is not a group member, therefore sets the transmit DG-ID default to 00 and the receive DG-ID to 00.

The examples of the user operation with the above settings:

- The group members USER-1, USER-2 and USER-3 may communicate the normal operation by using the CH-A frequency.
- When the USER-1 and the USER-2 are communicating with each other using CH-A, the USER-3 allows preferentially contact to the group members in an emergency by using the CH-B uplink frequency.
- USER-3 may change the repeater setting temporarily by using the uplink frequency even if CH-A is in use, and also record messages to members.
- Since the DG-ID is different for USER-4 who is not the group member, the uplink signal may not be repeated in the digital mode, but in the analog FM mode, USER-4 may transmit on the uplink and use this repeater, because the setting of CH-A is "AUTO AMS". When communicating only with group members, only the C4FM digital transceiver may be received by changing the operation mode of CH-A to FIX DIGITAL, so only the group members with the same DG-ID may communicate.

10. [Example] Advanced Set up and Operations

IMRS (Internet-linked Multi-site Repeater System)

The repeater, installed the optional LAN Unit LAN-01A and connected the multiple DR-2X/DR-2XE repeaters via the Internet, may be accessed as stand-alone or as a group repeater (Up to 99 units).

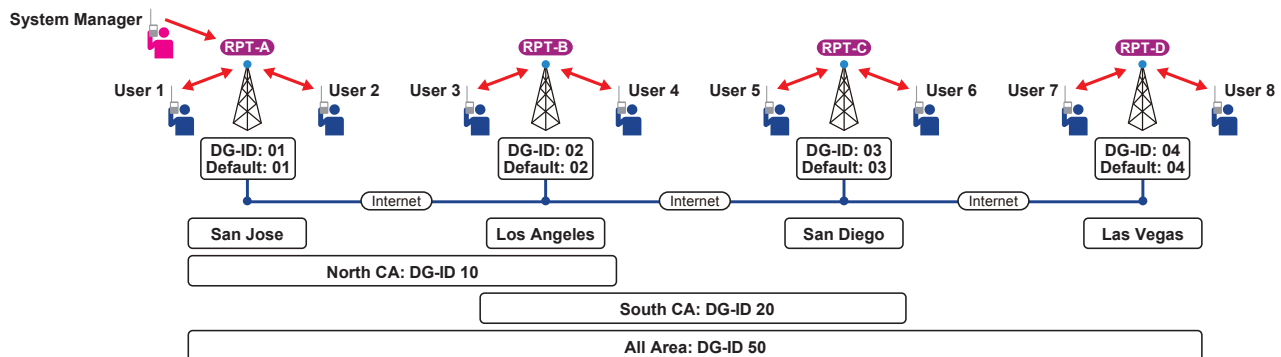

		RPT-A	RPT-B	RPT-C	RPT-D
LOCAL Name		San Jose	Los Angeles	San Diego	Las Vegas
LOCAL DG-ID		01	02	03	04
Default DG-ID		01	02	03	04
Group	Group Name	North CA			
	Group DG-ID	10			
	Group Name		South CA		
	Group DG-ID		20		
	Group Name	All Area			
	Group DG-ID	50			

USER-1 transmits the uplink signal with DG-ID 01

Only RPT-A transmits the downlink signal.

LOCAL DG-ID 01 (RPT-A)

USER-1 transmits the uplink signal with DG-ID 04

Only RPT-A and RPT-D transmit the downlink signal.

These settings are retained, even if the other members transmit the uplink signal from RPT-A and RPT-D with any DG-IDs during the time set by the TOT.

LOCAL DG-ID 04 (RPT-D) + UPLINK RPT-A

USER-1 transmits the uplink signal with DG-ID 10

RPT-A and RPT-B transmit the downlink signal.

The other members may transmit on the uplink from RPT-A or RPT-B with the same DG-ID.

USER-1 transmits the uplink signal with DG-ID 20

RPT-A, RPT-B and RPT-C transmit the downlink signal.

The other members may transmit on the uplink from RPT-A and RPT-B with the same DG-ID.

This setting state is retained until the TOT time passes after the last transmission, even if the other members transmit the uplink signal from this repeater with any kind of DG-IDs during the time set by the TOT.

GROUP DG-ID 20 (RPT-B + RPT-C) + UPLINK RPT-A

USER-1 transmits the uplink signal with DG-ID 50

All the repeaters transmit the downlink signal

These settings are retained until the TOT time elapses after the last transmission, even if the other members transmit on the uplink of any repeaters with any kind of DG-IDs.

GROUP DG-ID 50 (ALL REPEATERS)

The beep sounds to notify that the TOT is activated and accessed by DG-ID number other than the default DG-ID.

While the TOT is activated, transceivers may communicate without changing the transmit DG-ID for a certain period of time (TOT operating time) regardless of the transceiver DG-ID.

※: Selectable from 0/30sec/1min/1.5min/2min/2.5min/3min/4min/5min/10min/CONT. (Default 1min)

- When deactivating the TOT, transceiver beeps 2 times to notify that the TOT is deactivated with the downlink signal from all the linked repeaters.
- When RPT-D is performing local communication etc. and TOT is activated, it cannot be accessed from other repeaters. Transceiver beeps 3 times to notify that the accessed repeater failed to activate the downlink of the accessed repeaters.

● **Register all the DG-IDs used in the group for each DR-2X/DR-2XE.**

In the RPT Group, DG-ID registration screen of RPT-A, register all the DG-ID numbers 01,02, 03, 04, 10, 20, 50 used within the group members.

Similarly, all the DG-ID numbers 01, 02, 03, 04, 10, 20, 50 used in the group are also registered in RPT-B, RPT-C, RPT-D.

11. Remote Controls

Setting the remote control

- Remote control of the DR-2X/DR-2XE repeater can be performed in either C4FM digital mode or analog FM mode. For C4FM digital mode, use the FTM-100D, FTM-400D, FTM-400XD or FTM-3200D transceiver. For security reasons, we recommend using a mobile C4FM transceiver with the DP-ID that is registered to the DR-2X/DR-2XE repeater.
- Remote operation sends commands on the uplink frequency of CH-B. Response of the remote command and Voice Message are transmitted on CH-A's downlink frequency of normal operation.
- When remote control is required, it is necessary to set whether to control the DR-2X/DR-2XE with analog FM or C4FM in advance.

Selection of analog FM, C4FM digital

- 1 Touch **[A SETUP]** or **[B SETUP]** on the operation mode screen.
The setup mode screen will appear.
- 2 Touch **[F]** in the setup mode screen.
The setup menu will appear.
- 3 Touch **[MODE/REMOTE]**.
The menu list will appear.

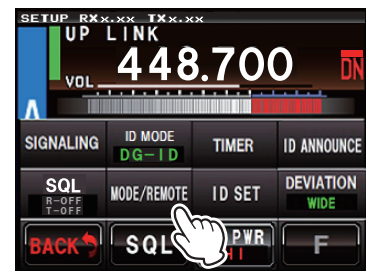

- 4 Select and touch **[COMMAND]**.
The command list will appear.

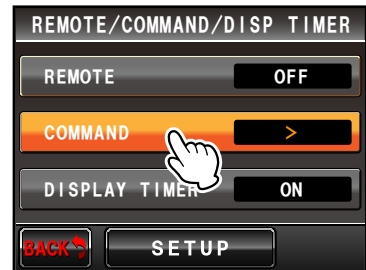

- 5 Touch **[CONTROL MODE]**.
The set value will change in the following sequence each time **[CONTROL MODE]** is touched.

▣ "DTMF" (Analog FM) ▣ "DIGITAL" (C4FM Digital) ▣



DIGITAL (C4FM Digital)



DTMF (Analog FM)

- 6 Touch **[BACK]** 4 times.
The screen returns to the operation mode screen.

C4FM DIGITAL CONTROL

- Requires the optional LAN Unit “LAN-01A” for digital voice storage and playback functions.
- Set the operation mode to “AUTO” or “FIX DIGITAL”.
- The transceivers compatible with the remote-control are the FTM-400D, FTM-400XD, FTM-100D and FTM-3200D.
- Remote control with C4FM digital can be done only when the transceiver DP-ID has been registered to the DR-2X/DR-2XE in advance. Remote operation cannot be performed with a transceiver when the DP-ID has not been registered, so you can securely manage repeaters.
- When the remote operation is accepted, the repeater responds and the operation completion is shown by the respective functions on the screen of the mobile transceiver.

DTMF (for analog FM mode)

- Requires the optional voice guide unit “FVS-2” for analog voice storage and playback functions.
- Set the operation mode to “AUTO”.
- Any transceiver with DTMF can be used.
- When the remote operation is accepted, the CW ID of the operation that has been completed by the respective function is transmitted on the repeater downlink frequency.

Remote Control Command List (Default setting)

Function	Description	C4FM	Analog FM	C4FM	Analog FM
		Code		Display of the transceiver screen	CW ID
ACTIVATE	Activate the repeater operation of CH-A and CH-B.	1111	*1111	Activate Set	O
DEACTIVATE (LOCAL)	Deactivate the local repeater operation.	2222	*2222	Local Deactivate Set	S
DEACTIVATE (ALL)	Deactivate all the linked repeaters.	2221*1	-	All Deactivate Set	-
FIX DIGITAL	Set the repeater to C4FM mode.	3333	*3333	DIGI/DIGI Set	DD
AUTO	Set the repeater to AMS (Automatic Mode Select) mode. Both analog FM and C4FM digital signals operate.	4444	*4444	AUTO/AUTO Set	AA
HIGH TX POWER	Set the transmit power to HI (50 W).	0050	*0050	High Power Set	H
MID TX POWER	Set the transmit power to MD (20 W).	0020	*0020	Mid Power Set	M
LOW TX POWER	Set the transmit power to LO (5 W).	0005	*0005	Low Power Set	L
REC MESSAGE	Record the voice message.	PTT*2	*5555	REC Completed	R
PLAY MESSAGE	Play (Stop) the voice message.	P2*2,*3	*6666	PLAY Completed	R
CLEAR MESSAGE	Clear the voice message.	P3*2,*3	*7777	CLEAR Completed	R
EMERGENCY CALL OFF	When accessing the repeater by a transceiver with registered DP-ID, select the downlink from all the linked repeaters or the downlink in accordance with the DG-ID setting.	8888*1	-	EMERGENCY OFF	-
EMERGENCY CALL ON		9999*1	-	EMERGENCY ON	-

*1: It is only available with the C4FM digital.

*2: When the C4FM digital mode, press the “PTT”, “P2”, or “P3” key.

*3: When using the FT-991A, touch “PLAY”, or “CLEAR”.

- When using Analog FM mode, hold down PTT, press the “*” key on the microphone, and then enter the DTMF code.
- When remote control is activated by a Digital Code, the status is shown on the transceiver display.
- When remote control is activated by DTMF, the status is responded with CW ID on the Downlink frequency.

Change the remote command

To change the factory command codes.

- 1 Touch [**A SETUP**] or [**B SETUP**] on the operation mode screen.
The setup mode screen will appear.
- 2 Touch [**F**] on the setup mode screen.
The setup menu will appear.
- 3 Touch [**MODE/REMOTE**].
The menu list will appear.
- 4 Touch [**COMMAND**] twice.
The command list will appear.
- 5 Touch [**◀▶**] to select the desired CONTROL MODE (DIGITAL or DTMF).
- 6 Touch [**▲**] or [**▼**] to select the desired command.
- 7 Touch the command to enable setting the remote control code.
- 8 Enter a 4-digit control code.
The screen returns to the command list.
- 9 Touch [**BACK**] 4 times.
The screen returns to the operation mode screen.

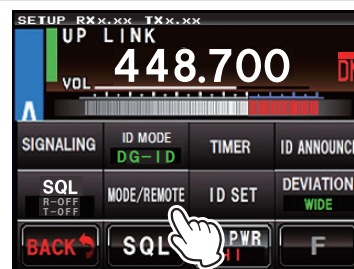

The same code as another function may not be set.

12. Actual remote control procedure

Remote Control for C4FM Digital

When controlling remotely with the C4FM Digital Mobile Transceiver

The C4FM digital transceivers that support the remote-control function are: FTM-400XD/D, FTM-300D, FTM-100D, FTM-7250D, FTM-3207D and FTM-3200D. (As of Oct 2020)

- 1 Be sure to confirm that the transceiver DP-ID is registered on the DR-2X/DR-2XE repeater.
- 2 Tune the transmit frequency of the transceiver to the uplink frequency of the CH-B side of the DR-2X/DR-2XE.
- 3 Press and hold the “*” key on the microphone.
- 4 “REMOTE REC/PLAY” or “REC/PLY” (Depending on the transceiver model) is displayed on the transceiver screen, the remote-control is available.
 - To cancel the remote-control, press the “*” key on the microphone.
- 5 Input the 4-digit remote command by using the numeric keys.
 - Press the “*” key on the microphone to cancel the input command at any point in the process.
- 6 Press the “#” key on the microphone to transmit the inputted command.
- 7 After transmitting the command, press the “*” key on the microphone to return to normal operation.



- If the FTM-400D/XD, FTM-100D or FTM-3200D firmware is not compatible with the DP-ID function, update the transceiver to the latest firmware to utilize the DP-ID functions.
- The latest firmware is available on the YAESU website.

When controlling remotely with the FT-991A

- 1 Please confirm that the FT-991A DP-ID is registered on the DR-2X/DR-2XE repeater.
- 2 Tune the transmit frequency of the FT-991A to the uplink frequency of the CH-B side of the DR-2X/DR-2XE.
- 3 Set the FT-991A to the digital mode.
- 4 Press the [F(M-LIST)] button, then touch and hold [AMS] on the LCD.
- 5 When “REMOTE” is displayed on the FT-991A screen, the remote-control is available.
 - To cancel the remote-control, touch [BACK] on the LCD.
- 6 Input the 4-digit remote command by touching the keys on the LCD.
 - Touch [BACK] on the LCD to cancel the input command at any point in the process.
- 7 Touch the “ENT” key on the LCD to transmit the inputted command.
- 8 After transmitting the command, touch [BACK] on the LCD to return to normal operation.



- If the FT-991A firmware is not compatible with the DP-ID function, update the transceiver to the latest firmware to utilize the DP-ID function.
- The latest firmware is available on the YAESU website.

Remote Control for Analog FM

Transmit the 4-digit DTMF codes from the transceiver to perform remote control.

- 1 Tune the transmit frequency to the uplink frequency of the CH-B side of the DR-2X/DR-2XE.
- 2 Set the transceiver to the analog FM mode.
- 3 While transmitting, press the “*” key on the microphone, and then use the numeric keys to input the preset 4-digit remote command.

13. Voice messages

Voice messages are a very useful feature to communicate messages to all club members. For example, when you plan a breakfast meeting on Sunday morning, if you record the location and time with the remote control, the message is transmitted from the repeater at a predetermined interval and number of times. For example, it is possible to set the message to announce ten times at an hourly interval.

Voice Message for C4FM Digital Mode

Remote control voice message using FTM-400D, FTM-400XD, FTM-100D or FTM-3200D

Recording, playback, and erasing are performed with the "PTT" "P2" "P3" keys of the transceiver's microphone.



In order to record a message, first register the transceiver DP-ID on the DR-2X/DR-2XE repeater.

- 1 Tune the transmit frequency to the uplink frequency of the CH-B side of the DR-2X/DR-2XE.
- 2 Set the transceiver to the C4FM digital mode, then press and hold the "*" key on the microphone.

To record a message:

Press the PTT to record. When you release the PTT, recording will end automatically and "REC Completed" will be displayed on the screen of the mobile transceiver.



Recording is possible for a maximum of 60 seconds.

To play and transmit the message:

Press the P2 key. The message will transmit once and "PLAY Completed" will be displayed on the screen of the mobile transceiver.

To erase a recorded message:

When the P3 key is pressed, the recorded contents are deleted and "CLEAR Completed" is displayed on the screen of the mobile transceiver.

- 3 Press the "*" key on the microphone to return to the normal operation.

Voice Message for Analog FM

Send 4-digit DTMF codes from the transceiver's microphone to record, play, or erase a voice message.

- 1 Tune the transmit frequency to the uplink frequency of the CH-B side of the DR-2X/DR-2XE.
- 2 Set the transceiver to the analog FM mode.

To record a message:

While transmitting, press the "*" key, then input the preset 4-digit command (initial value 5555) from the microphone. When the PTT is released, a CW code of "R" is sent on the downlink frequency. Press the PTT to record. When you release the PTT, recording stops automatically, and the CW code of "R" is transmitted on the downlink frequency.



- If a CW code of "NG" is returned when recording starts, the recording area of the FVS-2 is full. Execute the erase operation to clear the internal memory area.
- Recording is possible for a maximum of 60 seconds.

To play and transmit the message:

While transmitting, press the "*" key, then input the preset 4-digit command (initial value 6666) from the microphone. Once the message is transmitted, a CW code of "R" is sent on the downlink frequency.

To erase a recorded message:

While transmitting, press the "*" key, then input the preset 4-digit command (initial value 7777) from the microphone. The recorded content is erased and the CW code of "R" is transmitted at the downlink frequency.

14. Setting the interval and number of voice messages

The DR-2X/DR-2XE has a message function that automatically transmits the recorded message on the downlink frequency at specified intervals and number of times.

Setting the transmission interval of the message:

- 1 Touch [A SETUP] or [B SETUP] to display the frequency set up screen, then touch [F] on the bottom of the screen.
- 2 Touch [TIMER].

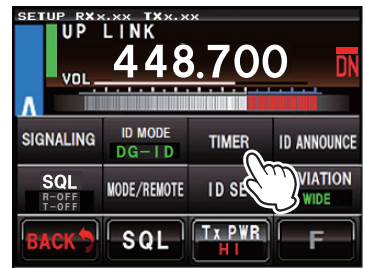

- 3 Touch [MESSAGE] twice.

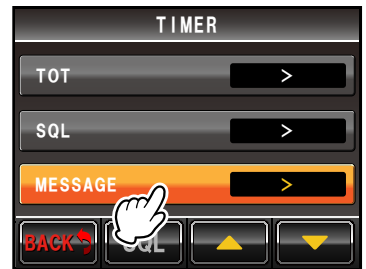

- 4 Touching [PLAY INTERVAL] switches the transmission interval as follows, then select the desired number of announcements.
 0.5 hour 1 hour 2 hour 3 hour



The default setting is "1 hour".



- 5 Touch [BACK] 4 times.
The screen returns to the operation mode screen.

Setting the number of message transmissions:

- 1 Touch [A SETUP] or [B SETUP] to display the frequency set up screen, then touch [F] on the bottom of the screen.
- 2 Touch [TIMER].

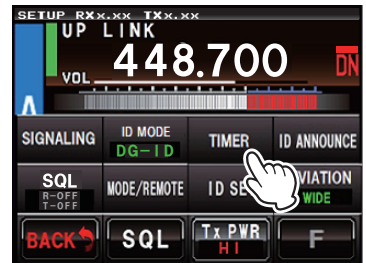

- 3 Touch [MESSAGE].

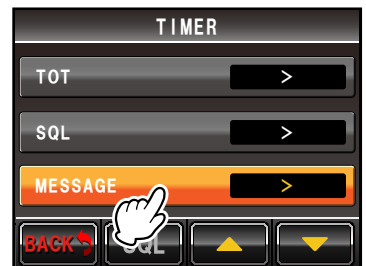

- 4 Touch [PLAY TIMES].
- 5 Touching [PLAY TIMES] switches the transmission play time as follows:
 1time 2times 3times 5times 10times 20times



The default setting is 5 times.

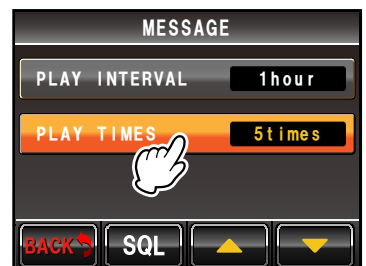

- 6 Touch [BACK] 4 times.
The screen returns to the operation mode screen.

15. Operate message function at the DR-2X/DR-2XE site

To Record a message for Analog FM:

- 1 Connect an optional MH-48A6JA or MH-42C6J microphone to the "MIC" jack on the front panel of the DR-2X/DR-2XE.
- 2 Touch [A SETUP] or [B SETUP] on the bottom of the Operation Mode Screen, then touch [F].

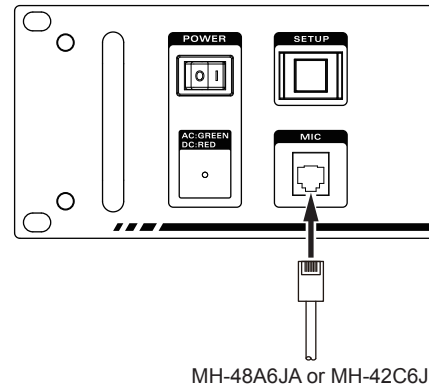

- 3 Touch [MODE/REMOTE].
- 4 Touch [COMMAND] twice.
- 5 Touch [CONTROL MODE] to select "DTMF".
- 6 Touch [▼].
[▶PLAY] will be displayed at the bottom of the screen.

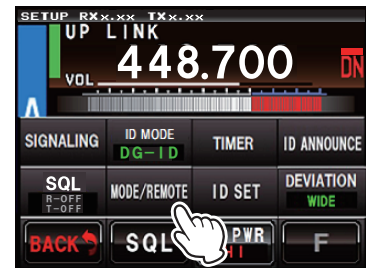

- 7 Press the PTT switch on microphone, [▶PLAY] will change to [●REC]. Speak into the microphone, the message is recorded until you release the PTT switch.



Recording is possible for a maximum of 60 seconds.



How to check recorded contents

- 1 Touch [A SETUP] or [B SETUP] on the bottom of the Operation Mode Screen, then touch [F].
- 2 Touch [MODE/REMOTE].
- 3 Touch [COMMAND] twice.
- 4 Touch [CONTROL MODE] to select "DTMF".
- 5 Touch [▼].
[▶PLAY] will be displayed at the bottom of the screen.

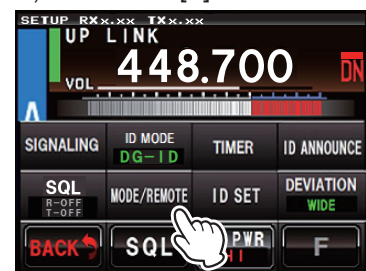

- 6 Touch [▶PLAY] to play the contents of the recording.



The recorded content will be played but will not be transmitted.

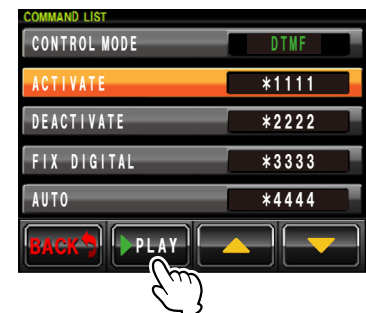

How to erase recorded contents:

- 1 Touch [A SETUP] or [B SETUP] on the bottom of the Operation Mode Screen, then touch [F].
- 2 Touch [MODE/REMOTE].
- 3 Touch [COMMAND] twice.
- 4 Touch [CONTROL MODE] to select "DTMF".
- 5 Touch [▼].
[▶PLAY] will be displayed at the bottom of the screen.

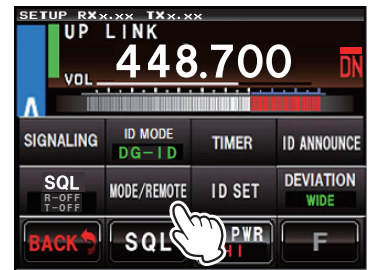

- 6 Touch and hold [▶PLAY].
[CLEAR ALL VOICE] will be displayed.



- 7 Touch [OK?] to erase all the recorded contents.
Touch [CANCEL] to cancel erasing.



Voice messages used with C4FM digital cannot be erased by operation of the DR-2X/DR-2XE.



16. Set Up Various Functions

Using the setup menu, the various functions of the repeater can be customized to match the desired applications. Items to be adjusted can be selected from the respective lists, and the settings entered or selected that are appropriate for the intended repeater operation.

- 1 Touch [A SETUP] or [B SETUP] on the operation mode screen.
The setup mode screen will appear.
- 2 Touch [F].
The setup menu will appear.

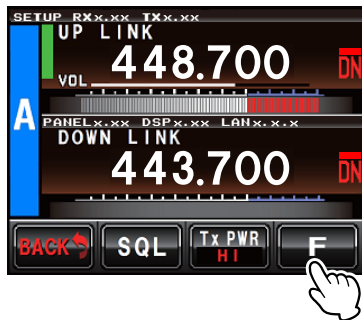

- 3 Touch the menu item.
The menu list will appear.

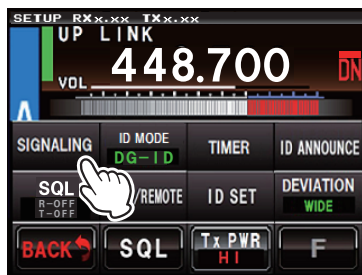

- 4 Touch the item to be set.
The item will turn orange in color.

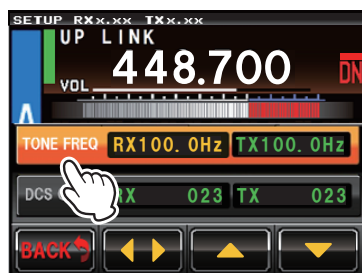

- 5 Touch [▲] or [▼], or touch the item repeatedly.
The set value will change each time it is touched.

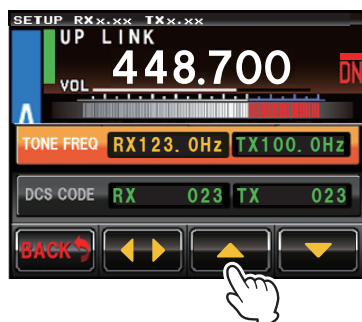

- 6 Touch [◀ ▶] to select the item.
The item will turn yellow in color.

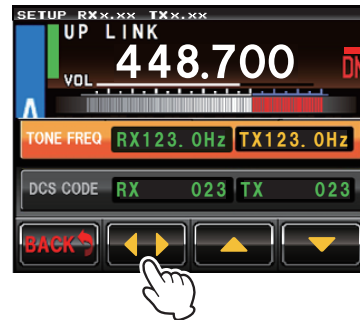

- 7 Touch [BACK].
The setting is determined and the display will return to the setup menu.

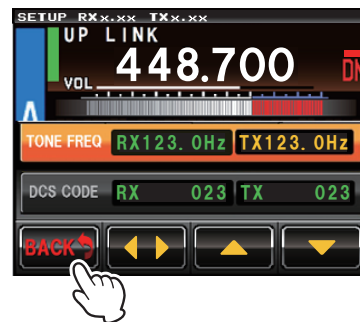

Setting the half deviation operation

- 1 Touch [A SETUP] or [B SETUP], and then touch [F].
- 2 Touch [DEVIATION] to display “NARROW”.
The setting will toggle between “NARROW” and “WIDE” each time [DEVIATION] is touched.
NARROW: Reduces the analog FM/C4FM digital modulation to half.
WIDE: Uses the normal analog FM/C4FM digital modulation.
- 3 Touch [BACK] twice.
The setting is determined and the display will return to the operation mode screen.

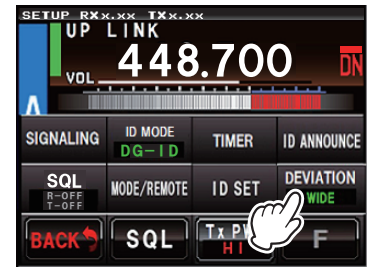

- Factory default: WIDE
- This setting item may be set on CH-A and CH-B individually.

Setting the tone signals for analog FM mode

Setting the tone frequency

- 1 Touch [A SETUP] or [B SETUP], then touch [F].
- 2 Touch [SIGNALING].
- 3 Touch [◀ ▶] to select the “RX TONE FREQ” and the “TX TONE FREQ”.
- 4 Touch [▲] or [▼].
The set value will change each time [▲] or [▼] is touched.
- 5 Touch [BACK] 3 times.
The setting is determined and the display will return to the operation mode screen.

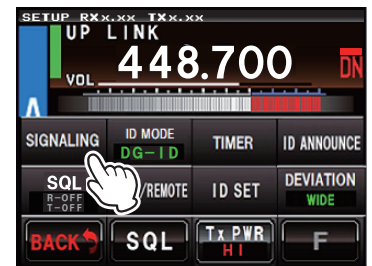

- Factory default: 100.0 Hz
- Tone frequencies between 67.0 Hz and 254.1 Hz can be selected.
- Both TX and RX can be set to different Tone frequency.
- This item may be set separately on the CH-A and CH-B.

Setting the DCS code

- 1 Touch [A SETUP] or [B SETUP], then touch [F].
- 2 Touch [SIGNALING], then touch [DCS CODE].
- 3 Touch [◀ ▶] to select the “RX DCS CODE” and the “TX DCS CODE”.
- 4 Touch [▲] or [▼].
The set value will change each time [▲] or [▼] is touched.
- 5 Touch [BACK] 3 times.
The setting is determined and the display will return to the operation mode screen.

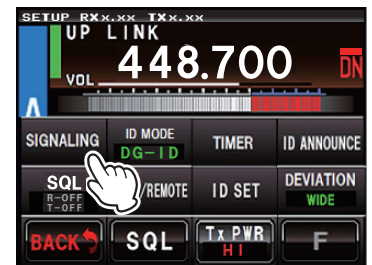

- Factory default: 023
- DCS codes between 023 and 754 can be selected.
- Each TX and RX can be set to different code.
- This setting item may be set on the CH-A and CH-B individually.

Set the tone signal type for analog FM mode

- 1 Touch [A SETUP] or [B SETUP], then touch [F], and then touch [SQL].
- 2 Select [RX SQL] to set the tone signal type during reception, or select [TX SQL] to set the tone signal type during transmission.
- 3 Touch [▲] or [▼].
The setting will change in the following sequence each time [▲] or [▼] is touched.
RX SQL: ►►► "OFF" ►►► "TONE" ►►► "DCS" ►►► "T-CALL" ►►► "T-CALL+TONE"
►►► "T-CALL+DCS" ►►►
TX SQL: ►►► "OFF" ►►► "TONE" ►►► "DCS" ►►►
- 4 Touch [BACK] 3 times.
The setting is determined and the display will return to the operation mode screen.

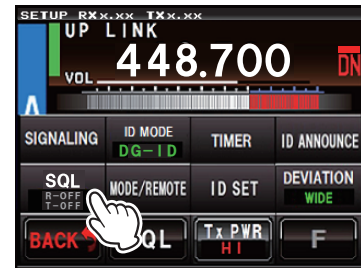

- Factory default: OFF
- When "T-CALL" is set, the relay starts after receiving 1750 Hz Tone Burst more than 0.5 second. When "T-CALL+TONE" or "T-CALL+DCS" is set, either T-CALL/TONE or T-CALL/DCS relays to receive.
- Both TX and RX can be set to different tone signal type.
- This item may be set separately on CH-A and CH-B.

Set the ID announcement for analog FM mode

Set the announcement mode

- 1 Touch [A SETUP] or [B SETUP], then touch [F], and then touch [ID ANNOUNCE].
- 2 Touch [ANNOUNCE], then touch [ANNOUNCE MODE].
The set value will change in the following sequence each time [ANNOUNCE MODE], [▲], or [▼] is touched.
►►► "CW" ►►► "CW wo TONE" ►►► "VOICE"※ ►►►
►►► "VC wo TONE"※ (VOICE wo TONE) ►►►
- 3 Touch [ANNOUNCE LEVEL].
The set value will change in the following sequence each time [ANNOUNCE LEVEL], [▲], or [▼] is touched.
►►► "HIGH" ►►► "MID" ►►► "LOW" ►►►
- 4 Touch [CW ID SPEED].
The set value will change in the following sequence each time [CW ID SPEED], [▲], or [▼] is touched.
►►► "16wd/min" ►►► "20wd/min" ►►► "24wd/min" ►►► "32wd/min" ►►►
- 5 Touch [BACK] 4 times.
The setting is determined and the display will return to the operation mode screen.

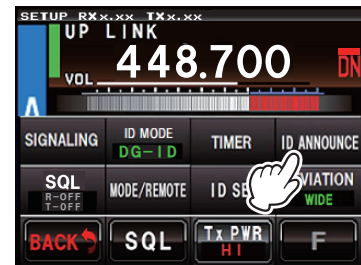

- Factory default:
ANNOUNCE MODE: CW
ANNOUNCE LEVEL: MID
CW ID SPEED: 20wd/min
- This setting item is common to CH-A and CH-B.
- When operating in the USA the CW ID SPEED setting time must not exceed 20 words per minute when keyed by an automatic device, to comply with the FCC rule Part 97: Sec. 97.119 (b)(1) Station identification.

Set announcement time interval

- 1 Touch [A SETUP] or [B SETUP], then touch [F].
- 2 Touch [ID ANNOUNCE], then touch [INTERVAL].
The set value will change in the following sequence each time [INTERVAL], [▲], or [▼] is touched.
 ►► “OFF” ►► “3min” ►► “5min” ►► “10min” ►►
 ►► “15min” ►► “20min” ►► “30min” ►► “TOT” ►►
- 3 Touch [BACK] 3 times.
The setting is determined and the display will return to the operation mode screen.

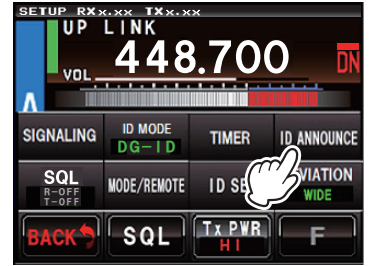

- Factory default: 10min
- This setting item is common to CH-A and CH-B.
- When “CW wo TONE” or “VC wo TONE” on “ANNOUNCE MODE” is set, the time interval is fixed at 10 minutes.
- When operating in the USA, the ID setting time should be ten minutes or less to comply with the FCC rule Part 97: Sec. 97.119 (a) Station identification.

Setting the SQL HYSTERESIS

- 1 Touch [A SETUP] or [B SETUP], then touch [F], and then touch [TIMER].
- 2 Touch [SQL] twice.
- 3 Touch [SQL HYSTERESIS].
The set value will change in the following sequence each time [SQL HYSTERESIS], [▲], or [▼] is touched.
 ►► “NORMAL” ►► “HIGH” ►► “MAX” ►►
- 4 Touch [BACK] 4 times.
The setting is determined and the display will return to the operation mode screen.

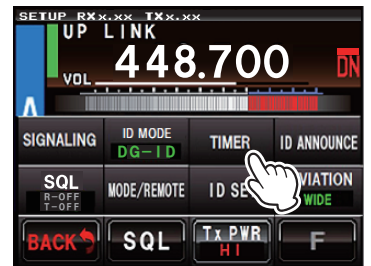

- Factory default: NORMAL
- This setting item is common to CH-A and CH-B.

Setting the SQL TAIL LENGTH

- 1 Touch [A SETUP] or [B SETUP], then touch [F], and then touch [TIMER].
- 2 Touch [SQL] twice.
- 3 Touch [SQL TAIL LENGTH].
The set value will change in the following sequence each time [SQL TAIL LENGTH], [▲], or [▼] is touched.
 ►► “0ms” ►► “50ms” ►► “100ms” ►► ►► “2500ms” ►►
- 4 Touch [BACK] 4 times.
The setting is determined and the display will return to the operation mode screen.

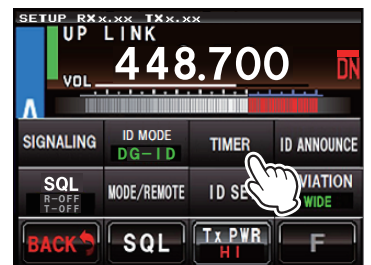

- Factory default: 0ms
- This setting item is common to CH-A and CH-B.

Setting the display turn-off time

- 1 Touch **[A SETUP]** or **[B SETUP]**, then touch **[F]**, and then touch **[MODE/REMOTE]**.
- 2 Touch **[DISPLAY TIMER]** to display "ON" or "OFF".
The set value will change between "OFF" and "ON" each time **[DISPLAY TIMER]** is touched.
- 3 Touch **[SETUP]**.
The display timer setting screen will be displayed.
- 4 Touch **[TIMER]**.
The set value will change in the following sequence each time **[TIMER]**, **[▲]**, or **[▼]** is touched (Default 1min).
 ►► "1min" ►► "5min" ►► "10min" ►► "30min" ►►
- 5 Touch **[BACK]** 4 times.
The setting is determined and the display will return to the operation mode screen.

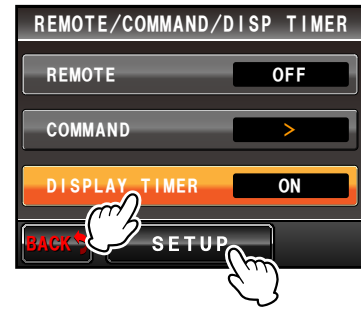

- Factory default:
DISPLAY TIMER: ON
TIMER: 1min
- This setting item is common to CH-A and CH-B.

Password

To continue operating the DR-2X/DR-2XE when the power is turned ON or after the display has been turned OFF, the password must be entered.



- Password is factory set to "0000". It is possible to change the password.
- If you forget your password, you will need to do an all reset. Please note that when all reset is performed, all settings and memory contents are returned to the factory default state.
- Use the factory default password "0000", unless it is necessary to change it for management security.

- 1 Touch **[A SETUP]** or **[B SETUP]**, then touch **[F]**, and then touch **[MODE/REMOTE]**.
- 2 If **[DISPLAY TIMER]** is set to "OFF", touch **[DISPLAY TIMER]** and turn it to "ON".
- 3 Touch **[SETUP]**.
- 4 Touch **[PASSWORD]** twice.
The character input screen will appear.
The touched character will be displayed at the top of the screen.
 - Four numeric characters can be entered.
 - The cursor in the input field moves left or right when **[←]** or **[→]** is touched.
- 5 Touch **[BACK]** 4 times.
The setting is determined and the display will return to the operation mode screen.

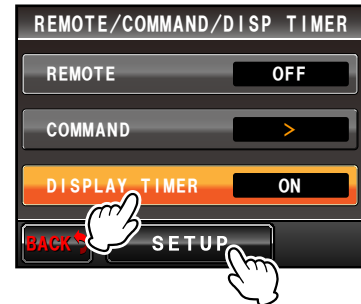

- The password input screen will be displayed when the power is turned ON, or after the display has been turned OFF. Enter the previously registered 4-digit password (default "0000").
- To reset the DR-2X/DR-2XE, press and hold in the **[SETUP]** button while turning the transceiver ON ►► the password input screen will appear ►► press and hold the **[SETUP]** button for 2 seconds ►► the reset confirmation screen will appear ►► touch "OK?".

17. Restoring Default Settings (Factory Reset)

- 1 Turn the DR-2X/DR-2XE OFF.
- 2 Press and hold in the **[SETUP]** button while turning the transceiver ON.



Continue pressing the **[SETUP]** button until the operation mode screen appears on the display.

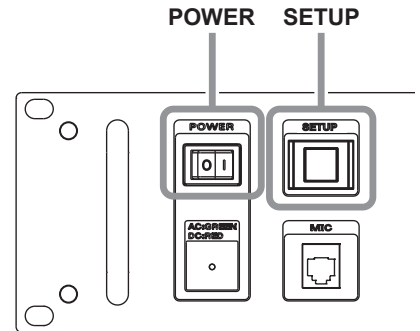

- 3 Touch **[A SETUP]**.
The setup mode screen will appear.

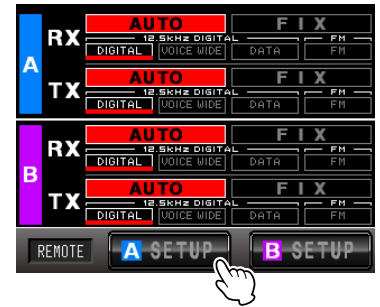

- 4 Touch **[F]** in the setup mode screen.
The setup menu will appear.
- 5 Touch **[F]**.
The reset confirmation screen will appear.

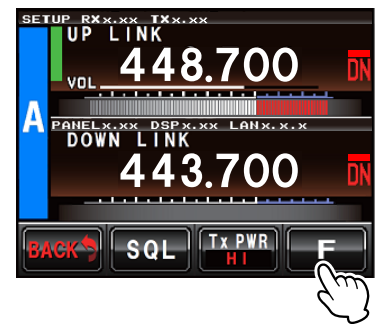

- 6 Touch **[OK?]**.
The settings will be reset to the factory default values.



18. Connect to the HRI-200 node station

To use WIRES-X with DR-2X/DR-2XE, connect HRI-200 directly to the 10-pin plug on the back of the DR-2X/DR-2XE.

Alternatively, there is a method the HRI-200 Node station may be located in a place different from the repeater site. In either case, you cannot use the HRI-200 when a LAN Unit "LAN-01A" is used.

Since the repeater site does not normally have a large capacity Internet line, and the HRI-200 must always be connected to the computer, it may be advantageous to set up the HRI-200 in a different location and uplink it to the repeater with the Node Station transceiver. It is recommended to downlink and connect to WIRES-X.

For HRI-200 and WIRES-X, please refer to their respective instruction manuals.

The following explains how to connect HRI-200 directly to DR-2X/DR-2XE.

Connecting HRI-200 to DR-2X/DR-2XE

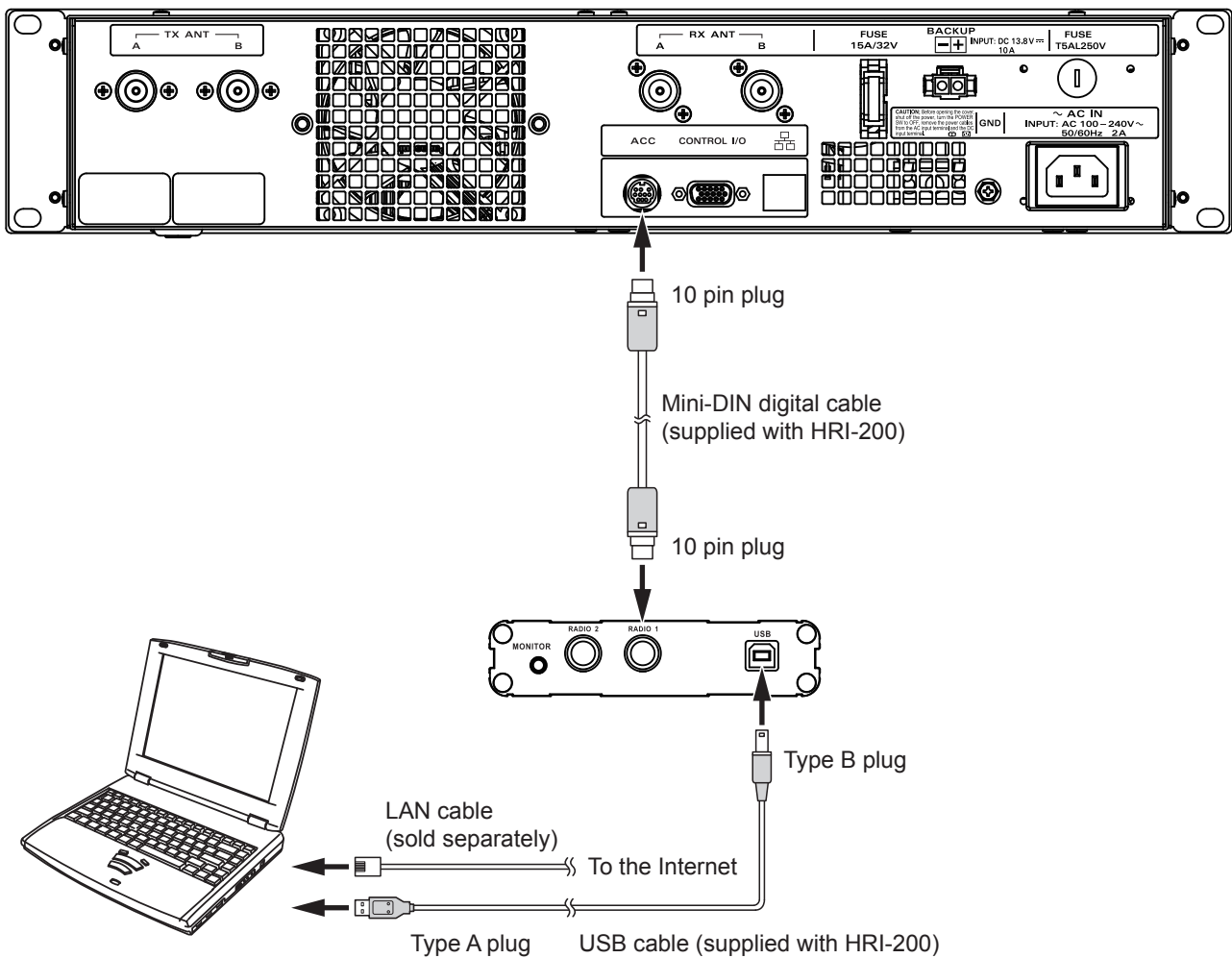

Change the repeater to the HRI mode

1. Turn the DR-2X/DR-2XE power OFF.
2. While pressing and holding the [SETUP] button, press the [POWER] switch.

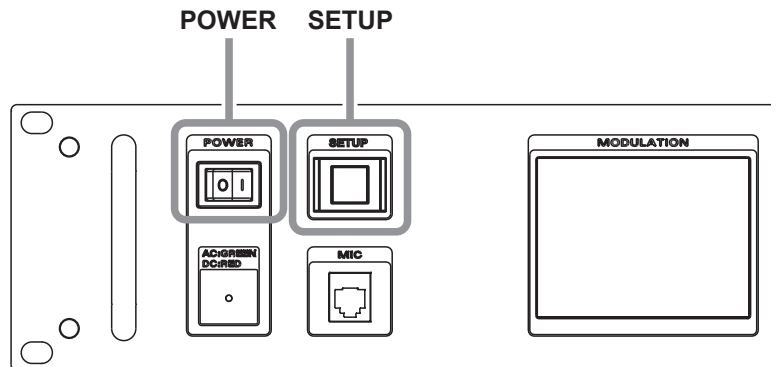

3. While the “YAESU” logo is being displayed, release the [SETUP] button.
“HRI+REPEATER MODE” will appear on the display.
4. Touch [OK?].
HRI mode will activate.



Return to REPEATER mode from HRI mode

1. Turn the DR-2X/DR-2XE power OFF.
2. While pressing and holding the [SETUP] button, press the [POWER] switch.

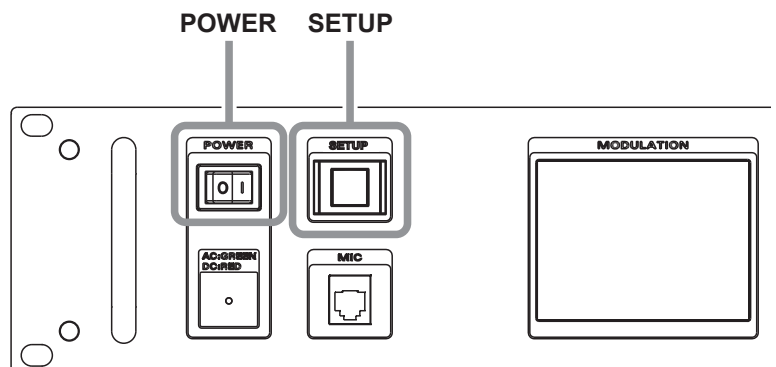

3. While the “YAESU” logo is being displayed, release the [SETUP] button.
“REPEATER MODE” will appear on the display.
4. Touch [OK?].
The operation mode screen will appear on the display.



19. Remote Operation with External Controller

Repeater operation may be controlled remotely by connecting an external controller through the [CONTROL I/O] connector at the back of the repeater.

The following features are available while in remote operation:

- Change the communication mode of repeater transmit and receive
- Turn the RX and TX tone signal “ON” or “OFF”
- Monitor the discriminator analog or demodulated digital audio during up-link reception

To use the repeater under remote control, set up the repeater as explained below, after it is connected to the external controller.

Turning remote operation ON/OFF

When the remote operation is “ON”, the repeater operates according to the control instructions received from the external controller (the instructions are received through Pin 11 to Pin 14 of the [CONTROL I/O] connector). When the remote operation is “OFF”, the repeater operates according to the settings determined through the setup mode.

- 1 Touch **[A SETUP]**.
The setup mode screen will appear.
- 2 Touch **[F]**.
The setup menu will appear.
- 3 Touch **[MODE/REMOTE]**.
The menu list will appear.
- 4 Touch **[REMOTE]**.
The set value will change between **[OFF]** and **[ON]** each time **[REMOTE]** is touched.



- Factory default: OFF
- Remote operation is available only on the CH-A.
- Remote operation is not available in the “HRI + REPEATER MODE”.

- 5 Touch **[BACK]** 3 times.
The setting is determined and the display will return to the operation mode screen.
Note that **[REMOTE]** at the bottom left of the screen is displayed in red.



You can transmit by the microphone and PTT input of the front panel in all settings except AMS/AMS.

Control from external controller

To control the DR-2X/DR-2XE remotely, optional cables can be used to connect the repeater to an external controller.

Use the “CONTROL I/O” connector at the back of the repeater to connect with the external controller.

To interface the DR-2X/DR-2XE with an external controller, additional cables with a 15-pin mini d-sub connector are needed to connect to the “CONTROL I/O” connector. Your controller may also require rewiring.

Link operation may require four connections: receiver audio, transmitter audio, receiver COR, and transmitter PTT; however, these are not available on the “CONTROL I/O” connector.

The pin assignment of the “CONTROL I/O” connector is as follows.

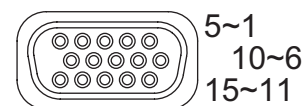

CONTROL I/O connector



(as viewed from rear panel)



Do not use a VGA cable for PC display to connect the external controller to the repeater.

Pin No	Pin Name	I/O	Descriptions																				
1	EXT I/O	Input	[L] GND: Remote mode [H] OPEN: Repeater mode																				
2	PTT	Input	[L] GND: EXT PTT ON [H] OPEN: EXT PTT OFF When this pin is pulled low by an external device, it keys the repeater transmitter.  On signaling while controlling the external PTT: Pin 6 (TONE IN) ... Valid Pin 7 (AF IN) ... Invalid																				
3	CTCSS/DCS (PKSQL)	Output	[L] GND: Decoded [H] OPEN: Undecoded Signaling settings in the repeater setup menu will be applied.																				
4	SQL DET (Noise SQL)	Output	[L] GND: SQL open [H] OPEN: SQL close This is an open-collector, active-low output capable of sinking about 10 mA. It indicates that the receiver squelch is open. If the squelch control is properly set, this indicates a carrier on the receiver channel.																				
5	GND	GND	Chassis ground for all logic levels and power supply return																				
6	TONE IN	Input	CTCSS/DCS EXT input / 600 ohm, 500 mV peak to peak Valid during external PTT control This pin is sub-audible tone input, and has a flat response characteristic (repeater deviation is constant for a given signal level over the frequency range of 5 ~ 250 Hz). Injecting a too high signal level here causes over-deviation of CTCSS or DCS, degrading performance. Use shielded cable to connect to this pin, connecting the shield to GND.																				
7	AF IN	Input	EXT Modulation input / 600 ohm, 1.5 V peak to peak Valid during external PTT control This pin is audio input (300 ~ 3,000 Hz). This audio is injected before the splatter filter stage, so excess signal input levels are clipped. It is impossible to input analog modulation signals and convert them to digital signals on DR-2X/DR-2XE. Use shielded cable to connect to this pin, and connect the shield to GND.  To use the external AF input, set the Pin11/Pin12 EXT port setting to RX: Auto (AMS) / TX: FM (FIX).																				
8	DISC OUT	Output	Up-link RX DISC output (w/o de-emphasis), 500 mV peak to peak Discriminator output during up-link reception. Does not affect the operation mode of the repeater. Received signals with standard deviation produce 500 mVp-p audio (300 - 3,000 Hz) are output at this pin. The signal is extracted before the de-emphasis and squelch circuitry. Use shielded cable to connect to this pin, and connect the shield to GND.																				
9	AF OUT	Output	Up-link RX AF output (w/ de-emphasis), 300 mV peak to peak Analog audio output during up-link reception. Does not affect the operation mode of the repeater. This pin is an output for AF signal (300 mVp-p), being extracted after the de-emphasis. Demodulated digital signals can be output as well.																				
10	GND	GND	Chassis ground for all logic levels and power supply return																				
11	EXT port 1*	Input	In Remote mode, the logic combination of Ports 1 and 2 determines the transmit and receive modes as below: <table border="1" data-bbox="734 1568 1401 1713"> <thead> <tr> <th>Port 1</th> <th>Port 2</th> <th>RX</th> <th>TX</th> </tr> </thead> <tbody> <tr> <td>H</td> <td>H</td> <td>Auto (AMS)</td> <td>Digital</td> </tr> <tr> <td>L</td> <td>H</td> <td>Digital</td> <td>Digital</td> </tr> <tr> <td>H</td> <td>L</td> <td>Auto (AMS)</td> <td>FM (FIX)</td> </tr> <tr> <td>L</td> <td>L</td> <td>Auto (AMS)</td> <td>Auto (AMS)</td> </tr> </tbody> </table>	Port 1	Port 2	RX	TX	H	H	Auto (AMS)	Digital	L	H	Digital	Digital	H	L	Auto (AMS)	FM (FIX)	L	L	Auto (AMS)	Auto (AMS)
Port 1	Port 2	RX		TX																			
H	H	Auto (AMS)	Digital																				
L	H	Digital	Digital																				
H	L	Auto (AMS)	FM (FIX)																				
L	L	Auto (AMS)	Auto (AMS)																				
12	EXT port 2*	Input																					
13	EXT port 3*	Input	[L] GND: RX Tone OFF [H] OPEN: Setup mode Input a low level signal to indicate that the receiving tone is invalid.																				
14	EXT port 4*	Input	[L] GND: TX Tone OFF [H] OPEN: Setup mode Input a low level signal to indicate that the transmitting tone is invalid.																				
15	VCC	VCC	Power supply This pin provides 13.8V, 2.0A, DC from the repeater supply. There is an internal 3 A fuse to prevent damage to the repeater.																				

* These functions may only be activated while the repeater is in Remote mode.

Pins 6, 7, 8, and 9 Functions Controlled by Operation Mode

Pin No	Pin Name	Receive Mode	In Repeater / Remote Mode
6	TONE IN	Digital	Invalid
		Analog	Invalid
7	AF IN	Digital	Invalid
		Analog	Invalid
8	DISC OUT	Digital	Invalid
		Analog	Discriminator output
9	AF OUT	Digital	Demodulated digital audio output
		Analog	Analog audio output



Even when using the DR-2X/DR-2XE with an external controller, the COR, analog and digital IDs, TOT, DCS/CTCSS, TX power, etc. are already controlled by the DR-2X/DR-2XE internal control. These internal controls cannot be disabled. The external controller must not conflict with these functions. Some functions of the internal controller cannot be overridden. Before connecting an external controller you must make sure which functions are already internally controlled. Special precautions must be considered when planning to link with external systems.



- Make sure to switch OFF the power to the radio before connecting the cable.
- In case of jamming or interfering signal while in Repeater mode, Pin 1 may be grounded by external control to temporarily disable repeating the receiver input.

To use DR-2X/DR-2XE in Remote mode

By setting [REMOTE] in the setup menu to ON and inputting a low level to Pin 1 of the [CONTROL I/O] connector, the repeater may be used in Remote mode and controlled remotely by the external controller. Pins 1, 8, 9, 11, 12, 13 and 14 may be used for input, output and control while in Remote mode.

For details, see "Remote Operation" (see page 42).

Setting to connect the repeater controller S-COM7330

Set up instructions to interface the Triple Repeater Controller S-COM7330 with the DR-2X/DR-2XE.

Modification of S-COM7330

- 1 Remove the 6 screws from each side and 2 screws from the top cover of the S-COM7330, then remove the top cover.
- 2 Change Jumper pin J10C or J11C or J3C and adjust the semi fixed. AF volume gain up for RX1 or RX2 or RX3.
- 3 Command Settings.
 - Select Path Access Mode: Carrier and CTCSS
 - Select COR Filter Delay: 300 msec
 - Select Dropout Delay: 0 sec

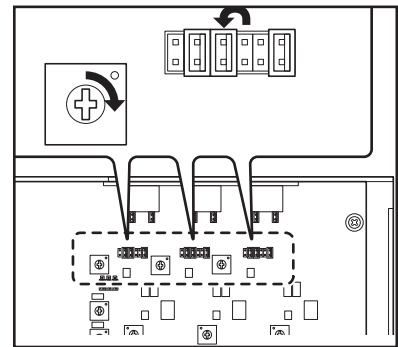

Setting of DR-2X/DR-2XE

Set the DR-2X/DR-2XE as follows.

- Setting the communication mode RX: AUTO (AMS)
TX: FM (FIX)
- Setting the tone signals: RX-TONE (100 Hz) (see page 35)

Connection with S-COM7330 and DR-2X/DR-2XE

DR-2X/DR-2XE		S-COM7330		Connection
pin 1	EXT I/O	pin 1	RX Audio	Connect to DR-2X/DR-2XE AF out
pin 2	EXT PTT	pin 2	RX COR	Connect to DR-2X/DR-2XE SQL DET
pin 3	CTCSS/DCS DET	pin 3	CTCSS in	Connect to DR-2X/DR-2XE CTCSS/DCS decode output
pin 4	SQL DET	pin 4	TX PTT	Connect to DR-2X/DR-2XE EXT PTT
pin 5	GND	pin 5	TX Audio	Connect to DR-2X/DR-2XE AF in
pin 6	TONE IN	pin 6	GND	DR-2X/DR-2XE GND
pin 7	AF IN	pin 7	GND	DR-2X/DR-2XE GND
pin 8	DISC OUT	pin 8	TX pin 8	Select TX LOGIC or TX CTCSS by JP pin
pin 9	AF OUT	pin 9	GND	DR-2X/DR-2XE GND
pin 10	GND	I/O Controller pin 1 to 6	Logic output	Connect to DR-2X/DR-2XE EXT I/O (needs S-COM programming)
pin 11	EXT PORT1	I/O Controller pin 1 to 6	Logic output	Connect to DR-2X/DR-2XE EXT PORT1 (needs S-COM programming)
pin 12	EXT PORT2	I/O Controller pin 1 to 6	Logic output	Connect to DR-2X/DR-2XE EXT PORT2 (needs S-COM programming)
pin 13	EXT PORT3	I/O Controller pin 1 to 6	Logic output	Connect to DR-2X/DR-2XE EXT PORT3 (needs S-COM programming)
pin 14	EXT PORT4	I/O Controller pin 1 to 6	Logic output	Connect to DR-2X/DR-2XE EXT PORT4 (needs S-COM programming)
pin 15	VCC OUT	DC jack	DC in	Connect to DR-2X/DR-2XE VCC out

The wiring paths shown by the dotted lines require programming the S-COM7330.

pin 1	EXT I/O	Jumper to pin 2 EXT PTT or connect to S-COM7330 LOGIC OUT (L: EXT I/O enable)
pin 2	EXT PTT	EXT PTT input from S-COM7330. It will be controlled by RX COR normally.
pin 3	CTCSS/DCS DET	Signaling decode output (CTCSS/DCS etc)
pin 4	SQL DET	Noise SQL decode output (Connect to RX COR)
pin 5	GND	GND
pin 6	TONE IN	Tone input from S-COM7330 (Connect to TX pin8)
pin 7	AF IN	Modulation input from S-COM7330
pin 8	DISC OUT	RX audio output without de-emphasis
pin 9	AF OUT	RX audio output with de-emphasis
pin 10	GND	GND

Connecting S-COM7330

S-COM7330



Repeater 1

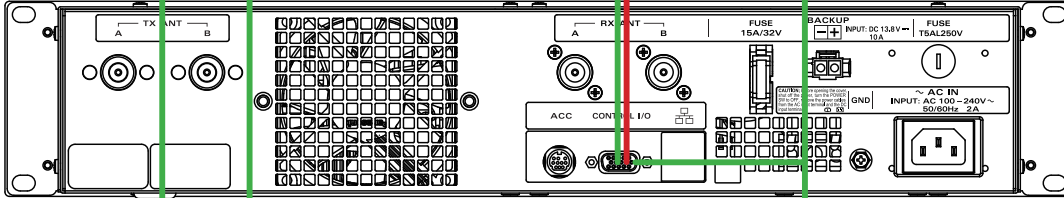

Repeater 2

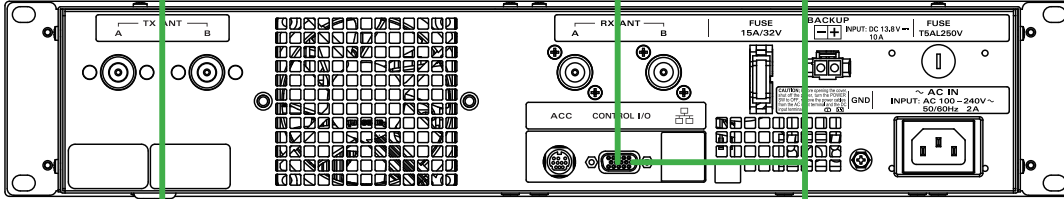

Repeater 3

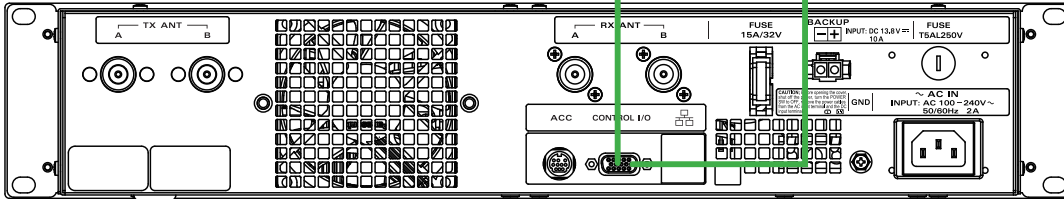

← This connection needs programming of S-COM7330.

20. Installation of the Optional Accessories

Installing the optional Voice Guide Unit FVS-2

- 1 Turn the DR-2X/DR-2XE [POWER] switch to "OFF".
- 2 Disconnect all the cables from the DR-2X/DR-2XE.
- 3 Remove the 4 screws from each side and 7 screws from the top cover of the DR-2X/DR-2XE, then remove the top cover.

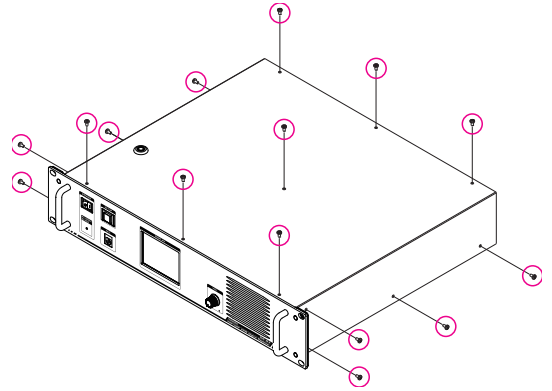

Figures in this page show the outline of the DR-2X.

- 4 Referring to Figure 1, remove the 4 screws from the top cover of the RX-UNIT, then remove the top cover.

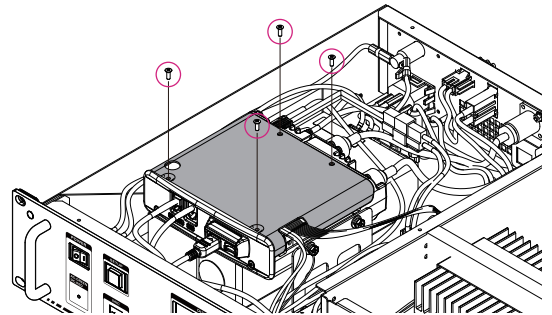

Figure 1

- 5 Refer to Figure 2 for the mounting location for the FVS-2.

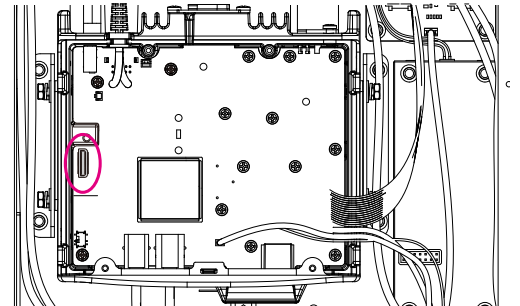

Figure 2

- 6 Push the FVS-2 (component side up) onto the pins corresponding to its assigned mounting location on the RX-UNIT. Gently press the FVS-2 down until it is firmly seated on the connector.

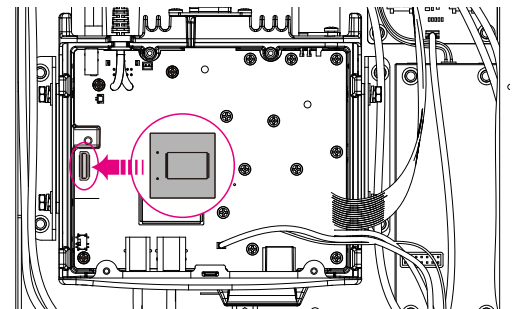

Figure 3

- 7 Replace the top cover of the RX-Unit and 4 screws.
- 8 Replace the top cover of the DR-2X/DR-2XE and 15 screws.

21. Specifications

● General

Frequency range	: 144 to 146 MHz, 430 to 440 MHz or 144 to 148 MHz, 430 to 450 MHz
Channel steps	: 5 / 6.25 kHz
Emission type	: F1D, F2A, F2D, F3E, F7W 16K0F1D F1D - Frequency modulation data transmission, double sideband, without using a modulating subcarrier 16K0F2D F2D - Frequency modulation data transmission, using a modulating subcarrier 16K0F3E F3E - Frequency modulation telephony 12K5F7W F7W - Two or more digital channels combinations of the above
Frequency stability	: ± 2.5 ppm (-4°F to $+140^{\circ}\text{F}$ (-20°C to $+60^{\circ}\text{C}$))
Antenna impedance	: 50 Ω
Supply voltage	: AC 100-240V (DR-2X only) DC 11.7 to 15.8 V, negative grounding
Current consumption	: AC: 2 A (max) (@ 117 V Input) (DR-2X only) DC: 1.5 A (receive) 10 A (50 W TX, 144 MHz / 430 MHz band)
Operating temperature	: DR-2X: -4°F to $+140^{\circ}\text{F}$ (-20°C to $+60^{\circ}\text{C}$) DR-2XE: -20°C to $+55^{\circ}\text{C}$
Dimensions	: 19" (W) \times 3.5" (H) \times 15" (D) (482 \times 88 \times 380 mm) w/o knob, connector, handle
Weight (approx.)	: DR-2X: 20.72 lbs (9.4 kg) DR-2XE: 18.52 lbs (8.4 kg)

● Transmitter

RF power output	: 50 / 20 / 5 W
Modulation type	: F1D, F2A, F2D, F3E Variable Reactance Modulation F7W 4FSK (C4FM)
Spurious emission	: At least 60 dB below

● Receiver

Circuit type	: Double conversion super-heterodyne
Intermediate frequencies	: CH-A 1st: 47.25 MHz, 2nd: 450 kHz CH-B 1st: 44.85 MHz, 2nd: 450 kHz
Receiver sensitivity	: 0.3 μV (Digital 144 MHz Band/430 MHz Band) BER 1 % 0.2 μV (FM 144 MHz Band/430 MHz Band) 12 dB SINARD
Adjacent Channel Selectivity	: Better than 65 dB TYP (20 kHz offset)
Selectivity	: FM 12 kHz/35 kHz (-6 dB/ -60 dB)
Intermodulation	: Better than 65 dB TYP (20 /40 kHz offset)
Audio output	: 4 W (4 Ω , THD 10%, 13.8 V; internal speaker)

● Symbols placed on the equipment

 Direct current



- Rated values are at normal temperature and pressure.
- Ratings and specifications are subject to change without notice for product improvement reasons.

22. After-market Services

The warranty period is 3 years from the date of purchase

The warranty certification is enclosed with the product. Malfunction resulting from normal use of the product in accordance with the Operating Manual instructions, shall be repaired free-of-charge within a 3-year period from the date of purchase.

Keep the warranty certificate in a safe location

When the warranty certificate is lost, failures which occur during the warranty period will be treated as chargeable non-warranty claims.

Contact Yaesu Service Center for non-warranty repairs

Repairs will be made at the user's expense if normal functions can be maintained after the repair. Please check with the retail store or Yaesu service center for more information.

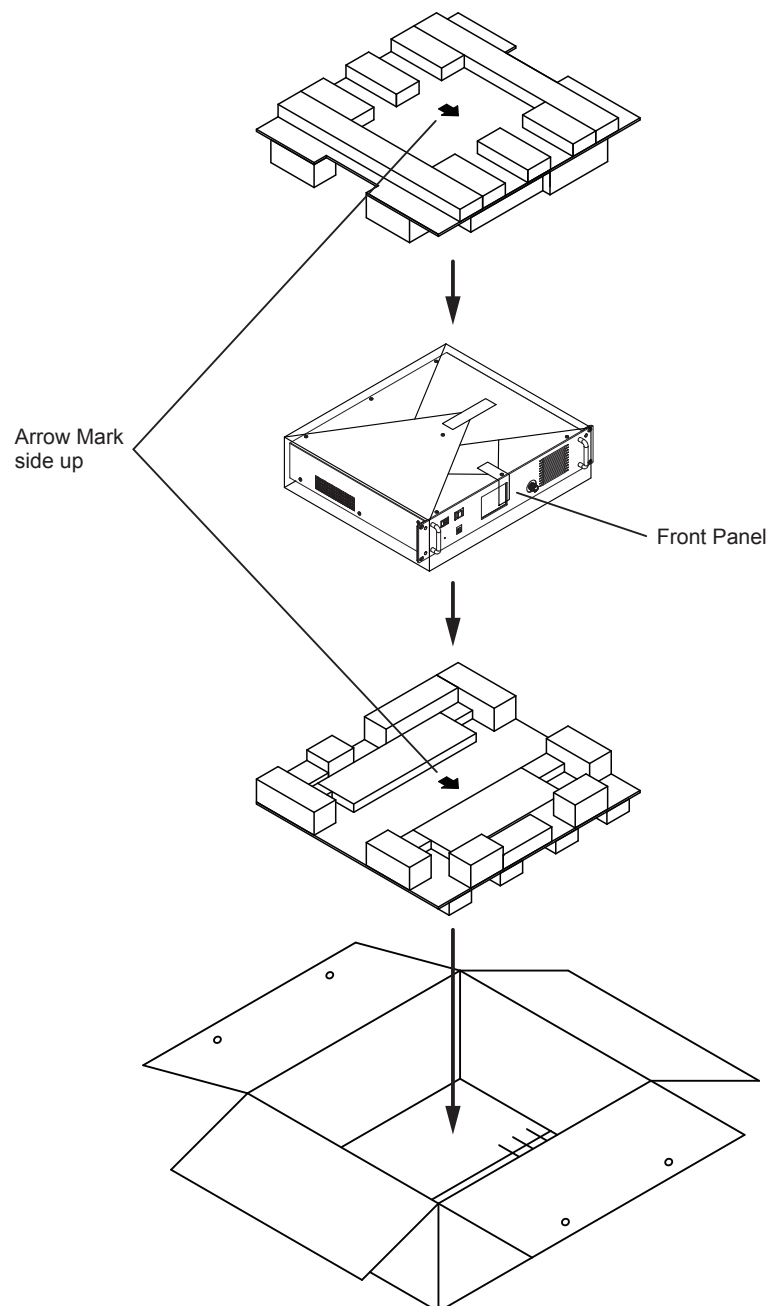

Note

Note

Note

This equipment has been tested and found to comply with the limits for a Class B digital device, pursuant to Part 15 of the FCC Rules. These limits are designed to provide reasonable protection against harmful interference in a residential installation. This equipment generates, uses and can radiate radio frequency energy and, if not installed and used in accordance with the instructions, may cause harmful interference to radio communications. However, there is no guarantee that interference will not occur in a particular installation.

If this equipment does cause harmful interference to radio or television reception, which can be determined by turning the equipment off and on, the user is encouraged to try to correct the interference by one or more of the following measures:

- Reorient or relocate the receiving antenna.
- Increase the separation between the equipment and receiver.
- Connect the equipment into an outlet on a circuit different from that to which the receiver is connected.
- Consult the dealer or an experienced radio/TV technician for help.

This device complies with part 15 of the FCC Rules. Operation is subject to the following two conditions: (1) This device may not cause harmful interference, and (2) this device must accept any interference received, including interference that may cause undesired operation.

EU Declaration of Conformity

We, Yaesu Musen Co. Ltd of Tokyo, Japan, hereby declare that this radio equipment DR-2XE is in full compliance with EU Radio Equipment Directive 2014/53/EU. The full text of the Declaration of Conformity for this product is available to view at <http://www.yaesu.com/jp/red>

ATTENTION – Conditions of usage

This transceiver works on frequencies that are regulated and not permitted to be used without authorisation in the EU countries shown in this table. Users of this equipment should check with their local spectrum management authority for licensing conditions applicable for this equipment.

					
AT	BE	BG	CY	CZ	DE
DK	ES	EE	FI	FR	UK
EL	HR	HU	IE	IT	LT
LU	LV	MT	NL	PL	PT
RO	SK	SI	SE	CH	IS
LI	NO	–	–	–	–

Disposal of Electronic and Electrical Equipment

Products with the symbol (crossed-out wheeled bin) cannot be disposed as household waste. Electronic and Electrical Equipment should be recycled at a facility capable of handling these items and their waste by-products. Please contact a local equipment supplier representative or service center for information about the waste collection system in your country.



YAESU

The radio

Copyright 2020
YAESU MUSEN CO., LTD.
All rights reserved.

No portion of this manual may be
reproduced without the permission of
YAESU MUSEN CO., LTD.

YAESU MUSEN CO., LTD.

Tennozu Parkside Building
2-5-8 Higashi-Shinagawa, Shinagawa-ku, Tokyo 140-0002 Japan

YAESU USA

6125 Phyllis Drive, Cypress, CA 90630, U.S.A.

YAESU UK

Unit 12, Sun Valley Business Park, Winnall Close
Winchester, Hampshire, SO23 0LB, U.K.

2002H-DS-1
Printed in Japan



E H 0 6 3 U 2 0 3